

radex

AIRLINE FILTER

INSTRUCTION MANUAL

Read all instructions and warnings before using this product.
Save this manual for future reference.



Instruction Manual

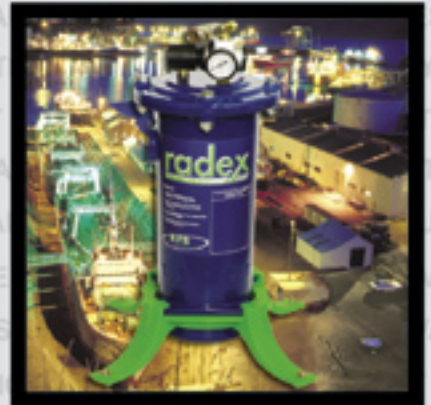

INTRODUCTION	3
WARNINGS	4-5
ASSEMBLY	6,7,8
OPERATION	9
MAINTENANCE	10,11
PARTS LIST	12

RPB 62/2

INTRODUCTION

The Radex Airline Filter is designed to remove oil mist, water vapour and particulates down to 0.5 micron from breathing grade compressed air.

The Radex Airline Filter meets OSHA regulation 1910.94 (6) (i), requiring a trap and carbon filter be installed and regularly maintained to remove objectionable odours, as well as water, oil mist and other particulates.

The Radex Airline Filter also meets 1910.94 (6) (ii) by providing a pressure reducing valve to reduce the pressure to the requirements of supplied air respirators, providing that the inlet pressure does not exceed 125 psig (860 kpa). The Radex Airline Filter when fitted with micromist filter Part No. 04-925 is designed to remove oil mist, water vapour and particulates down to 0.001 micron complying with ISO8573.1 Class 1 Air Quality.

!DANGER!

Do not connect the Radex Airline Filter to bottled air that does not have a pressure reducing valve that will reduce the air pressure to a maximum of 125 psig (860 kpa). Failure to comply with this warning could cause the Radex Airline Filter to explode, causing serious injury or death

! WARNINGS !

1. The Radex Airline Filter should be assembled, operated and maintained by trained and experienced users.
2. Read all instructions and warnings before assembling and using the Radex Airline Filter. Failure to adhere to all instructions and warnings could result in serious injury or death.
3. Do not connect the Radex Airline Filter to any air source unless you have confirmed that it supplies breathable grade air. Failure to connect the airline filter to the proper air source could result in serious injury or death.
4. Do not modify or alter this Radex Airline Filter. Use only genuine RPB Respiratory replacement parts. Use of non genuine parts could reduce filtration capabilities.
5. Do not remove the safety pressure relief valve. Air will be released when pressure in the filter exceeds 125 psig (860 kpa).
6. Air supplied to the Radex Airline Filter must be at least Grade D quality air as described in the compressed gas association commodity specification G – 7.1 and OSHA regulation 1910. 134 (d)
7. The Radex Airline Filter DOES NOT REMOVE CARBON MONOXIDE (CO) OR TOXIC FUMES. Carbon monoxide alarms, monitoring devices or removal devices must be used in conjunction with this Radex Airline Filter.

! WARNINGS !

8. Do not use the Radex Airline Filter if it has been damaged as the Filter is a pressure vessel and damage to the vessel could cause fatigue that could result in serious injury or death. Do not attempt to weld the filter unit.
9. If the Radex Airline Filter is being used in conjunction with abrasive blasting, do not use abrasives containing free silica. The use of silica sand can cause respiratory diseases that cause death.
10. Always use NIOSH, CE or AS approved supplied air respirators. The type of supplied air respirator suitable for each application must be determined by your employer.
11. Always mount the Radex Airline Filter on a secure level surface.
12. Moisture must be drained on a regular basis to keep air supply free of moisture.
13. Do not loosen the bolts on the Radex Airline Filter lid while the unit is pressurized. All air must be drained from the filter and air supply to the inlet must be shut off completely before performing any work on the Radex Airline Filter.

ASSEMBLY

BASE MOUNT

The base mount can be attached in two positions, wall mount or floor mount. To connect the base mount align the arrows on the base mount with the arrows on the filter, Fig 1.1 for floor mount, Fig 1.2 for wall mount. NOTE: The base mount will only fit in two positions, the arrows must align before locking.

Turn the filter in a clockwise direction and lock into position. You will hear a click when the base is in the final position.

Fig 1.1 Floor mount

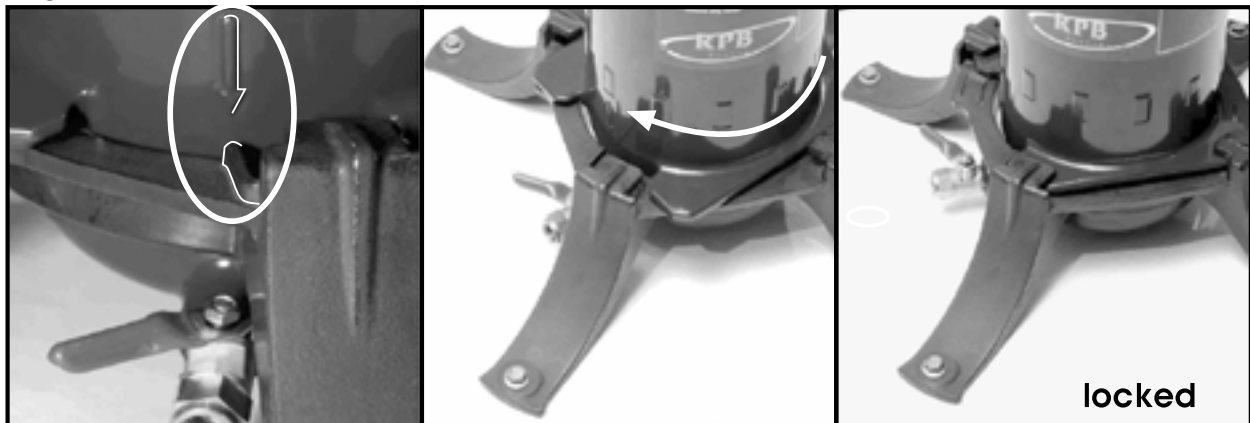

Fig 1.2 Wall mount



ASSEMBLY

PRESSURE REGULATOR

To assemble the pressure regulator, thread the pressure gauge into the body (refer Fig 2.1) and tighten. Connect the quick disconnect coupler and brass cap to the 3/8" tee and thread the 3/8" tee into the top of the pressure regulator and tighten (refer Fig 2.2). It is recommended that the regulator assembly is tightened before mounting onto the Radex Airline Filter. Use thread sealant on all fittings.

Fig 2.1



Fig 2.2

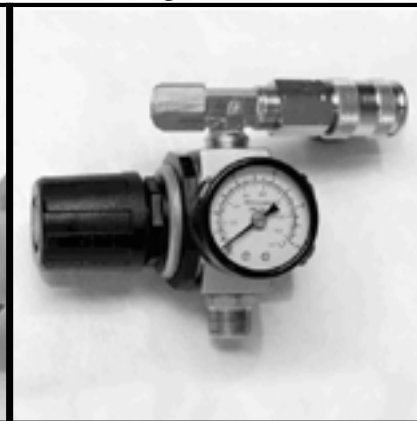

Fit the completed regulator assembly into the top of the Radex Airline Filter lid (refer Fig 2.3). Once the regulator assembly has been tightened into position you can fit the pressure relief valve and tighten (refer Fig 2.4)

! WARNING ! The pressure relief valve must be connected to protect the Radex Airline Filter from over pressurizing.

Fig 2.3

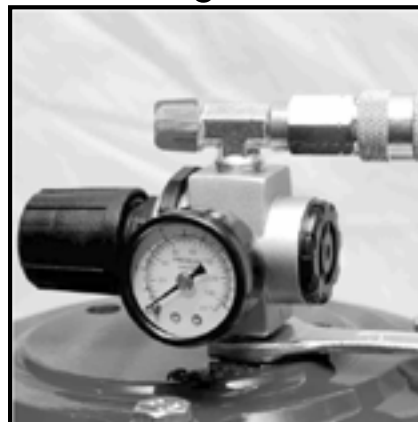
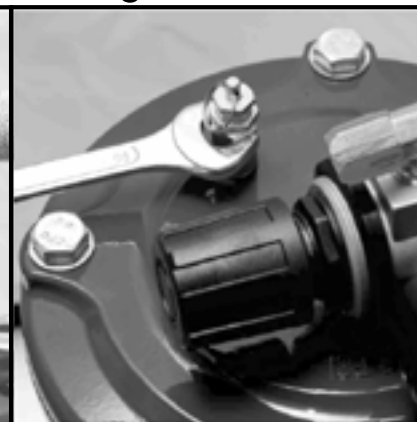

Fig 2.4



ASSEMBLY

INLET CONNECTION

The Radex Airline Filter has a 1" Npt inlet. It is advised to connect a ball valve close to the inlet so the unit can be shut off for servicing. Connect inlet fittings and tighten. Once the Radex Airline Filter is completely assembled and connected to compressed air open supply line and check fitting for any air leaks, tighten accordingly. **!WARNING!** Do not over tighten fittings, as over tightening could crack the Filter Casting.

FITTING OPTIONAL MICRO MIST FILTER

To fit optional micro mist filter 04-925, first thread the reducing nipple 04-926 into the micro mist filter then thread into the filter inlet and tighten, ensure the micro mist filter is positioned straight so it drains moisture from the collection bowl. (fig. 31)

Fig 3.1



OPERATION

AIR PRESSURE

The air pressure supplied to the Radex Airline Filter should not exceed 125psig (860 kpa). Air will be released from the pressure relief valve when the pressure in the Radex Airline Filter exceeds 125 psig (860 kpa).

When setting the outlet pressure using the pressure regulator refer to your respirator instruction manual to set the correct air pressure.

AIR TEMPRETURE

Air supplied to the Radex Airline Filter should not exceed 140 degrees Fahrenheit (60 degrees Celsius). Do not connect the Radex Airline Filter directly to the compressor outlet manifold.

AIR QUALITY

The Radex Airline Filter does not remove carbon monoxide and other toxic gases from the breathing air supply. A Carbon monoxide monitor must be used at all times. Supplied air passing through this Radex Airline Filter must meet the requirements of Grade D. EN12021 or AS/NZS 1715 refer to your relevant authorities for copies of these standards. Regular tests of the compressed air must be carried out to ensure it meets the requirements for breathable air.

AIR CONNECTIONS

Connect air fittings that meet the requirements of OSHA for respirable air. The inlet thread size is 1" Npt. All connections should be sealed using liquid thread sealant. If the Radex Airline Filter is hard piped an isolation valve must be used to enable depressurisation for servicing.

MAINTAINENCE

FILTER CARTRIDGE REPLACEMENT

The filter cartridge should be inspected weekly or more often depending on usage and the conditions of the air system in which the Radex Airline Filter is installed. The filter cartridge should be replaced after a period of 3 months based on a 40 hr week. The filter cartridge must be replaced immediately if the following exist:

- The presence of odour and or tastes in the air being supplied to the respirator.
- Presence of moisture at the outlet fittings.
- Large pressure drop across the filter

REPLACING CARTRIDGE

1. Shut off the air supply to the Radex Airline Filter and drain all air from the body by opening the drain tap.
2. Remove the bolts from the lid and separate the lid from the body.
3. Remove the cartridge and dispose in an appropriate disposal area.
4. Clean the inside of the filter body to remove any contaminants, do not clean with volatile chemicals.
5. Insert a new filter cartridge and reassemble the lid, tighten the bolts in the pattern drawn in (Fig 4.1) tighten to 10ft/lb torque.

Fig 4.1

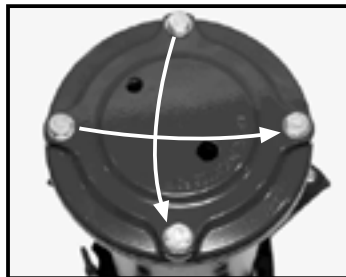

6. Record the date on the sticker supplied with the filter cartridge and place on to the Radex Airline Filter

MAINTAINENCE

DRAINING MOISTURE

Water will accumulate in the filter tank, this should be drained by opening the ball valve. This should be done each day. In very humid climates or if there is large amounts of water in the air supply it is recommended to leave the ball valve partially open to bleed the moisture.

When fitted with auto drain assembly (04-924) moisture will automatically drain from the unit as required. It is recommended that the auto drain is rinsed in water to keep clean and free of particles which could cause blockages.

LID BOLTS, ORINGS

The Radex Airline Filter lid bolts should be checked to ensure that they are tight. The lid bolts (04-920) should be replaced when replacing the filter cartridge.

The recommended tightness for the lid bolts is 10ft.lbs
Check the orings (04-919) and replace if damaged.

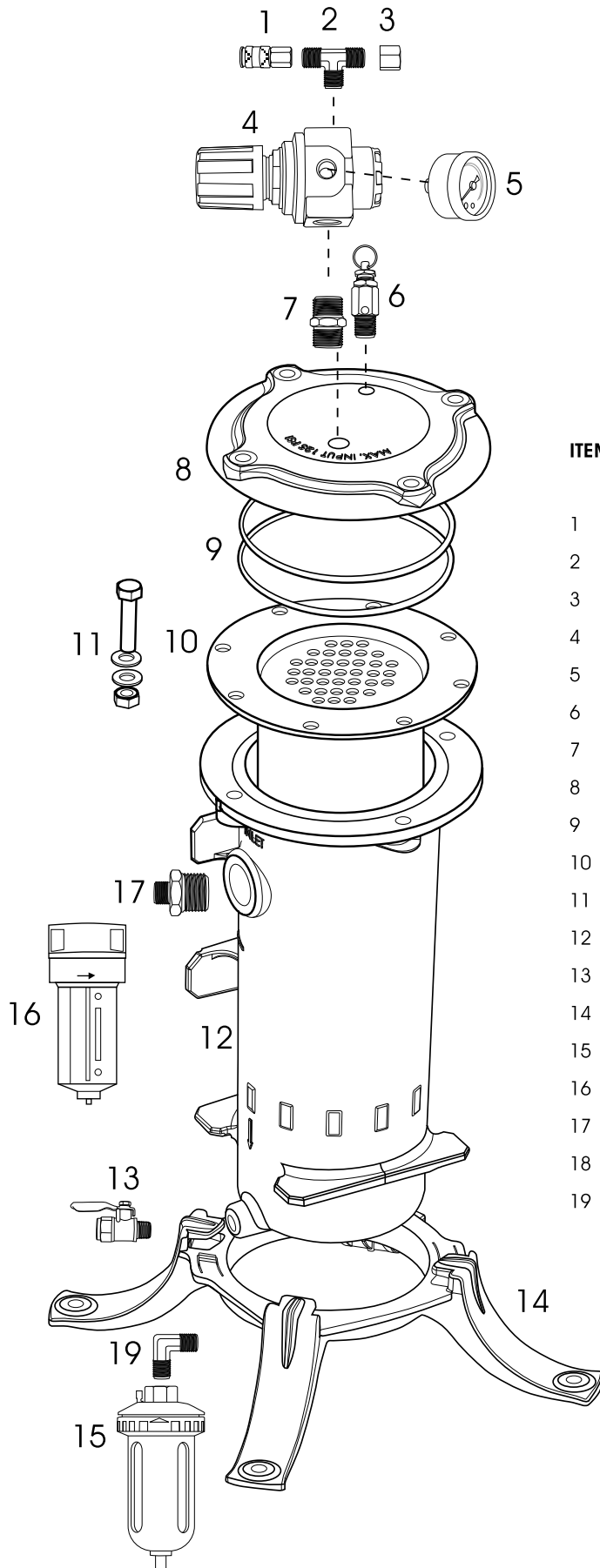

ITEM	DESCRIPTION	PART NO.
1	Quick Disconnect Coupler	04 - 911
2	3/8" Tee	04 - 912
3	3/8" Cap	04 - 913
4	Pressure Regulator	04 - 914
5	Pressure Gauge	04 - 915
6	Pressure Relief Valve 125 psi	04 - 916
7	3/8 Hex Nipple	04 - 917
8	Lid	04 - 918
9	O-ring (set of 2)	04 - 919
10	Filter Cartridge	APF3100
11	Bolt, Nut Washer set x4	04 - 920
12	Body	04 - 921
13	Drain Tap	04 - 922
14	Base Mount	04 - 923
15	Auto Drain Unit	04 - 924
16	Micro Mist Filter 1/2	04 - 925
17	1" x 1/2 Reducing Nipple	04 - 926
18	Main line Pre Filter	04- 927
19	Brass Elbow	04- 928



Did you know... We can also supply you with the following!



The **NOVA 2000** has been designed for blasting professionals. The NOVA 2000 is the most advanced abrasive blasting helmet available, with fully padded pillow foam liner for extra comfort and noise attenuation, wide angle vision, even air distribution ensures a pleasant working environment, optional climate control devices. Things cannot get much better!



ASTRO is your number one choice economic Abrasive Blasting Helmet, which meets safety standards worldwide. This is the lightweight, robust Helmet you have been waiting for. It helps to reduce fatigue, reduce down time and increase productivity.



Stay cleaner with **Head Socks** and **Spray Hoods**. One size fits all. The cool comfortable Spray Hood protects from over spray and sanding dust. The Head Sock can be worn as a hygienic helmet liner.



These large capacity six stage **Filter Cartridges** remove moisture and particulates to 0.5 micron & odor from the compressed air stream, providing you with clean breathable air.



CONTACT YOUR DISTRIBUTOR TODAY!

Phone: 1-866-494-4599 Fax: 1-866-494 4509 Email: info@rpbresp.com