

# PosiTector® 6000 Series

Coating Thickness Gages for  
**ALL** Metal Substrates

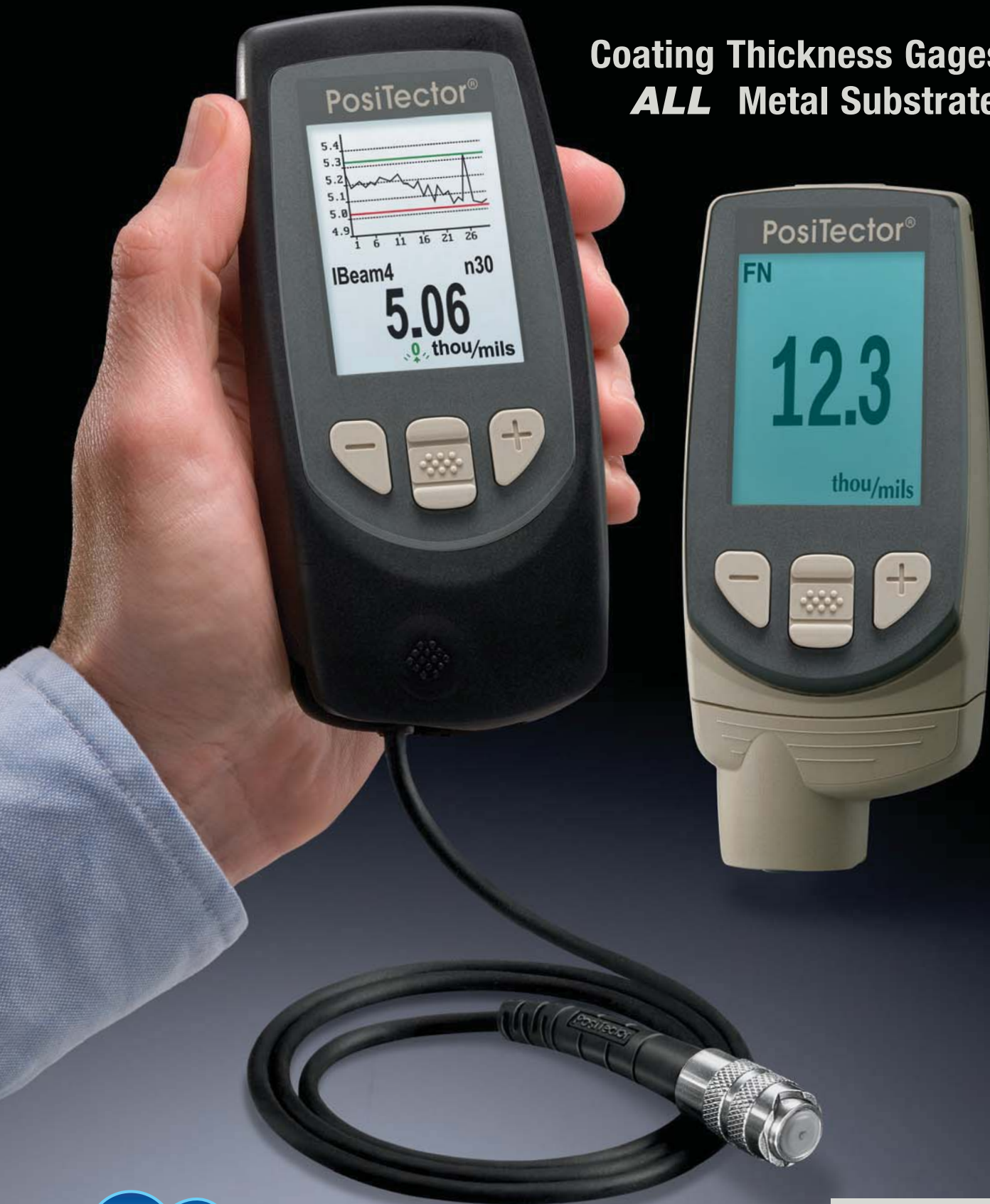

**DeFelsko®**

The Measure of Quality

# PosiTector® 6000 Series

## All Gages Feature...

### Simple

- Ready to measure—no calibration adjustment required for most applications
- Enhanced one-handed menu navigation
- Flashing display—ideal in a noisy environment
- RESET feature instantly restores factory settings

### Durable

- Solvent, acid, oil, water and dust resistant—weatherproof
- Wear-resistant probe tip
- Shock-absorbing, protective rubber holster with belt clip
- Two year warranty on gage body AND probe

### Accurate

- Certificate of Calibration showing traceability to NIST included
- Built-in temperature compensation ensures measurement accuracy
- Hi-RES mode increases displayed resolution for use on applications that require greater precision
- Conforms to national and international standards including ISO and ASTM

### Versatile

- Fully interchangeable probes are compatible with ALL gage bodies
- Multiple Calibration adjustment options including 1 point, 2 point, known thickness, average zero
- Selectable display languages
- Hi Contrast backlit display for bright or dark environments
- Flip display enables right-side-up viewing
- Extended cables available (up to 75 m/250 ft) for remote measuring
- Uses alkaline or rechargeable batteries (built-in charger)

### Powerful

- Continually displays/updates average, standard deviation, min/max thickness and number of readings while measuring
- HiLo alarm audibly and visibly alerts when measurements exceed user-specified limits
- FAST mode—faster measurement speed for quick inspection
- USB port for fast, simple connection to a PC and to supply continuous power. USB cable included
- USB mass storage—stored readings and graphs can be accessed using universal PC/Mac web browsers or file explorers. No software required
- Every stored measurement is date and time stamped
- Software updates via web keep your gage current
- Connects to PosiTector.net (see far right panel)

## Probes available for a variety of applications



For measuring paint, powder, etc. on all metals...



...and for measuring galvanizing, plating, anodizing and more.

## Gage Selection...

### Select Substrate

- F** — for ferrous metals (steel and cast iron)
- N** — for non-ferrous metals (aluminum, copper, etc.)
- FN** — for all metal substrates—Gage automatically recognizes the substrate and takes a measurement

### Select Standard or Advanced Features

#### Standard Models

Includes ALL features as shown on left plus...

- Monochrome display
- Storage of 250 readings—stored readings can be viewed or downloaded

#### Advanced Models

Includes ALL features as shown on left plus...

- Hi Contrast reversible color LCD
- Storage of 100,000 readings in up to 1,000 batches and sub-batches
- Onscreen help, real time graphing, picture prompting and batch notes
- Data transfer via USB to a PC or via Bluetooth® Wireless Technology to a PC or printer
- Scan mode—take continuous readings without lifting the probe
- Multiple stored calibration adjustments for measuring on a variety of substrate conditions
- SSPC PA2 feature determines if film thickness over a large area conforms to user-specified min/max levels
- PSPC 90/10 feature determines if a coating system complies with an IMO performance standard for protective coatings

### Select from a variety of measurement ranges and probe styles

(see back page ordering guide)

Heavy-duty, gold-plated locking connector for industrial environments



Removable Built-in Probe can be detached and replaced with any one of our wide variety of probes including separate probes and microprobes





## Rugged Features...

Sealed USB Port for communicating with a PC or Mac

Water and dust resistant—weatherproof

Hi resolution color LCD

Scratch/solvent/impact resistant lens

Multi-function navigation button

Solvent, acid, oil resistant, hi-grade, industrial strength housing

**Advanced Model shown in Memory Mode**

Quality high-flex cable and strain relief

Stainless steel probe with knurled finger grip

Strong wear-resistant ruby-tipped probe

All Regular Separate Probes are suitable for underwater use



where your gage meets the cloud™



**A free web-based application offering secure centralized management of thickness readings**

- Synchronize measurement data when connected via USB—measurements are uploaded to a secure server; images and batch notes are downloaded to your gage
- Manipulate uploaded data using a standard internet web browser from any location in the world—job site or head office
- Generate reports and graphs with annotations and user selected images
- Share measurement data with authorized users via a secure login from any computer and most web enabled devices
- Export data to XML and text files
- Visit [www.defelsko.com/PosiTectorNET](http://www.defelsko.com/PosiTectorNET) for a demonstration



Standard model shown in Statistics Mode with shock-absorbing, protective rubber holster











High-Range Probes for thick coatings, e.g. fire proofing, tank linings, etc.



Flip Display enables right-side-up viewing



Microprobe series for small parts and hard-to-reach areas

<b>PosiTector® 6000 Series</b> <b>ORDERING GUIDE</b>		Our most popular Removable Built-in and Regular Separate probe models			90° Regular probe for tight spots	Ideal for anodized aluminum	Microprobes – Our smallest probes for small parts or hard-to-reach areas			Removable Built-in and Separate probes for thick protective coatings; epoxy, rubber, intumescent fire proofing and more		
												
<b>Non-Magnetic Coatings over FERROUS Metals (Steel and Iron)</b>	Standard	F1	FS1	FRS1		FOS1	F45S1	F90S1	FT1	FTS1	FKS1	
	Advanced	F3	FS3	FRS3		FOS3	F45S3	F90S3	FT3	FTS3	FKS3	
<b>Non-Conductive Coatings on NON-FERROUS Metals (Aluminum, Copper, etc.)</b>	Standard	N1	NS1	NRS1	NAS1	NOS1	N45S1	N90S1			NKS1	
	Advanced	N3	NS3	NRS3	NAS3	NOS3	N45S3	N90S3			NKS3	
<b>Combination ALL METALS</b>	Standard	FN1	FNS1	FNRS1						FNTS1		
	Advanced	FN3	FNS3	FNRS3						FNTS3		
<b>Range</b>		0 – 60 mils 0 – 1500 µm			Ferrous: 0 – 45 mils and 0 – 1150 µm Non-Ferrous: 0 – 25 mils and 0 – 625 µm			0 – 250 mils 0 – 6 mm		0 – 500 mils 0 – 13 mm		
<b>Accuracy*</b>		±(0.05 mils + 1%) 0 – 2 mils ±(0.1 mils + 1%) > 2 mils ±(1 µm + 1%) 0 – 50 µm ±(2 µm + 1%) > 50 µm			±(0.02 mils + 1%) 0 – 4 mils ±(0.1 mils + 3%) > 4 mils ±(0.5 µm + 1%) 0 – 100 µm ±(2 µm + 3%) > 100 µm			±(0.5 mil + 1%) 0 – 100 mils ±(0.5 mil + 3%) > 100 mils ±(0.01 mm + 1%) 0 – 2.5 mm ±(0.01 mm + 3%) > 2.5 mm		±(1 mil + 3%) 0 – 500 mils ±(0.02 mm + 3%) 0 – 13 mm		
<b>Matching DeFelsko Calibration Standards</b>		STDS1 STDA1			STDS2 STDA2			STDP1		STDP5		

\*Accuracies are stated as a fixed value plus a percentage of the gage's actual reading. EXTENDED CABLES available for underwater or remote measuring. Specify length when ordering.

## Probe Details

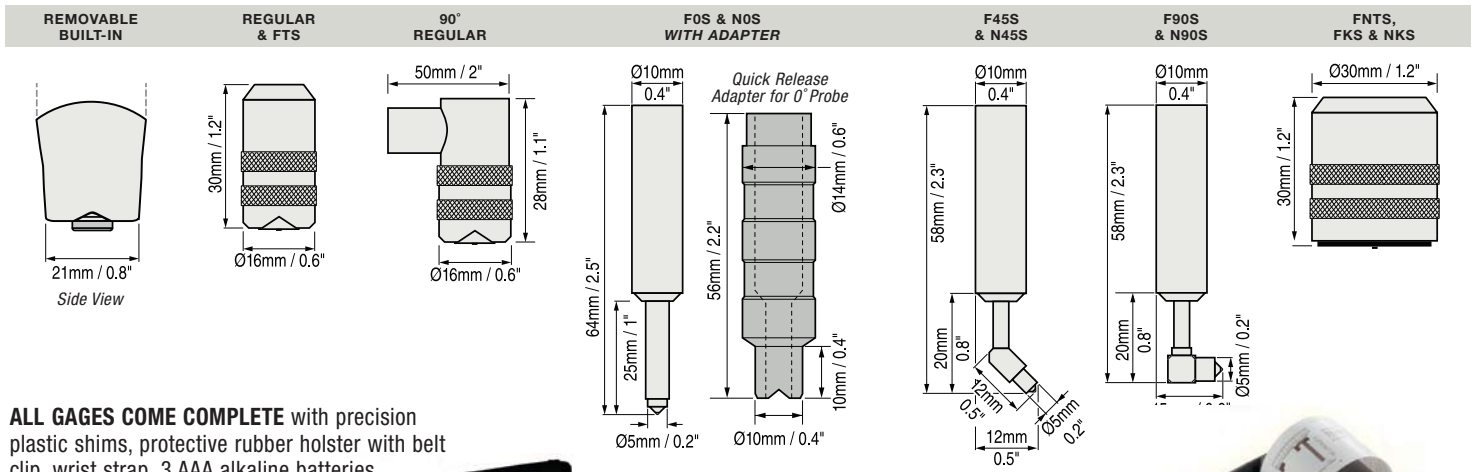

**ALL GAGES COME COMPLETE** with precision plastic shims, protective rubber holster with belt clip, wrist strap, 3 AAA alkaline batteries, instructions, nylon carrying case with shoulder strap, protective lens shield, Long Form Certificate of Calibration traceable to NIST, USB cable, two (2) year warranty.

**SIZE:** 137 x 61 x 28 mm (5.4" x 2.4" x 1.1")

**WEIGHT:** 140 g (4.9 oz.) without batteries

Conforms to ISO 2178/2360/2808, PrEN ISO 19840, ASTM B499/D1186/D1400/D7091/E376/G12, BS3900-C5, SSPC-PA2 and others



## Options

**Bluetooth Printer** receives data from Advanced models

**AC Power Kit** for continuous operation or battery charging—works in any country

**Coating Thickness Standards** to fulfill both ISO and in-house quality control requirements

**Rechargeable Batteries**—a set of eneloop NiMH AAA batteries

**Protective Lens Shields** protect the display from overspray



**DeFelsko®**  
The Measure of Quality

Distributed by:



Corrosion Control Equipment and Supplies

Houston Office:  
248 McCarty Dr.  
Houston, TX 77029

(713) 672-8251  
Fax (713) 672-6636

1-800-CLEMTEX  
www.clemtex.com  
houston@clemtex.com

Dallas Branch:  
4770 Cresta  
Dallas, TX 75207  
(214) 631-0584  
Fax (214) 631-5824

1-800-BLAST97  
dallas@clemtex.com  
Corpus Christi Branch:  
4750 Westway  
Corpus Christi, TX 78408  
(361) 882-8282  
Fax (361) 882-8029  
corpus@clemtex.com

Made in U.S.A.