

Distributed by:



**Corrosion
Control
Equipment
and
Supplies**

Houston Office:
248 McCarty Dr.
Houston, TX 77029-1195
(713) 672-8251
Fax (713) 672-6636

1-800-CLEMTEX
www.clemtex.com
clemtex@clemtex.com

Dallas Branch:

4770 Gretna
Dallas, TX 75207
(214) 631-0584
Fax (214) 631-5824
1-800-BLAST 97

Corpus Christi Branch:

4750 Westway
Corpus Christi, TX 78408
(361) 882-8282
Fax (361) 882-6029

Accessories Guide

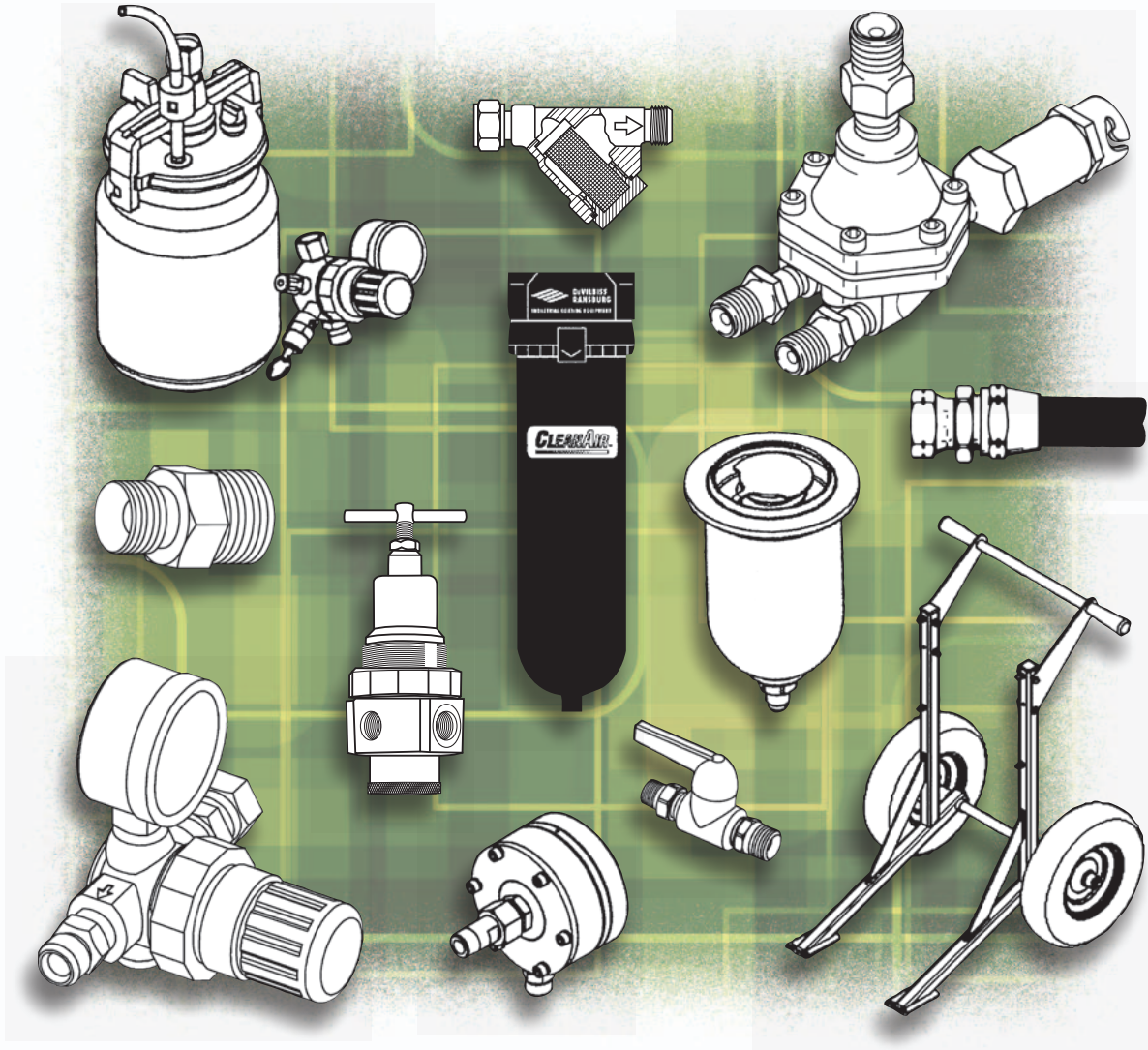

*Use genuine Binks and Devilbiss Accessories,
Repair Kits and Replacement Parts to keep your equipment
at peak performance*

Navigating this PDF

The Table of Contents features links to each section of this *Accessories Guide*. Click on any line in the Table of Contents to jump to that page.

To return to the Table of Contents, use the included bookmark in the **Bookmarks Panel**, which can be opened by clicking the **Bookmark icon** to the left of the main window (see illustration below), or through the menu interface: **View > Navigation Panels > Bookmarks**.

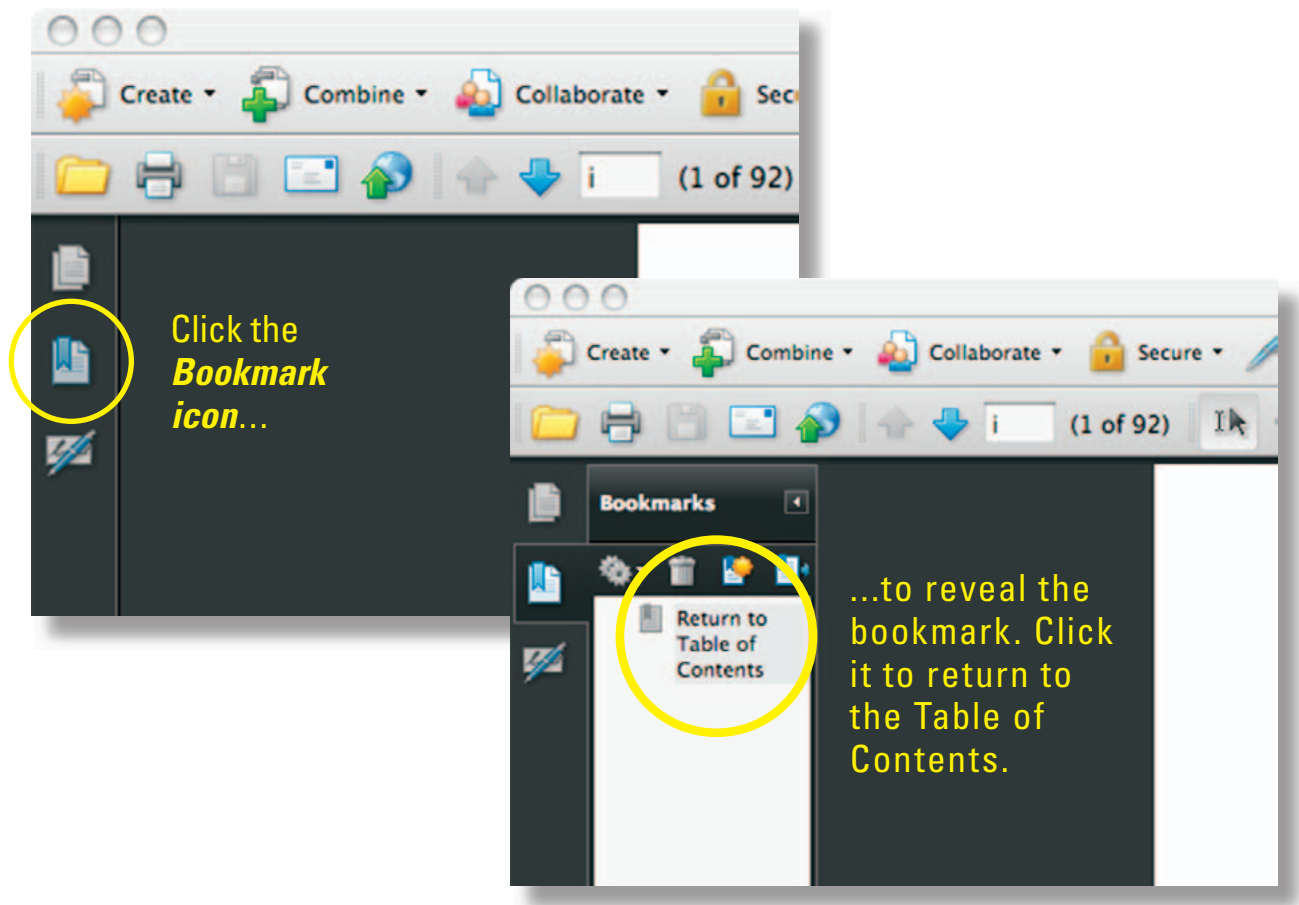

Table of Contents

1. PUMP MOUNTING HARDWARE & ACCESSORIES

Pump Mounting Hardware	1-2
Pump Carts & Stands	1-3
Bung Adapters	1-3
Pail & Drum Covers	1-4
Drum Elevator	1-5
Ground Wire Kits	1-5
Air Line Lubricators	1-5
Pump Protectors / Air Runaway Valves	1-5
Air Motor Mufflers	1-6
Gun/Outlet Manifolds	1-6
Siphon Hoses / Sets (5 & 10 Gallon)	1-7
Siphon Hoses / Sets (55 Gallon)	1-8

2. FLUID FILTERS, SCREENS/STRAINERS, FILTER ELEMENTS & FILTER/SURGE CHAMBERS

Material Filters, Strainers, Screens	2-2
High Pressure In Line Filters	2-3
Low Pressure In Line Filters	2-3
Low Pressure In Line Y Strainers	2-4
Inlet Screens (Rock Catchers)	2-4
Gun Mounted Mini Strainer	2-4
High Pressure Pump Filter Elements	2-5
High Pressure In Line Filter Elements	2-5
Low Pressure In Line Filter Elements	2-5
Surge Chambers / Pulsation Dampeners	2-6

3. FLUID REGULATORS, GAUGES & HEATERS

Fluid Regulators	3-4
Back Pressure Regulators	3-6
Gun Mount Non-Circulating Regulators	3-10
Gun Mount Circulating Regulators	3-10
Fluid Regulator Kits	3-12
Pressure Gauges	3-13
Fluid Heaters & FRP Heater Kits	3-14

4. AIR & FLUID VALVES

Ball Valves (Low Pressure)	4-2
Ball Valves (High Pressure)	4-2
Ball Valves (Air Vent)	4-3
VA Series Valves (Air & Fluid)	4-3
Air Adjustment Valves	4-4
Pressure Safety Relief Valves	4-4

5. HOSE, CONNECTIONS & ASSEMBLIES

Reusable Connections	5-2
Understanding Pressure Drop	5-3
Technical Data	5-4
Bulk Air Hose & Connections	5-5
Bulk Fluid Hose & Connections	5-8
Tubing & Connections	5-9
Air Hose Assemblies	5-12
Fluid Hose Assemblies	5-14
FRP Hose Assemblies	5-19
Catalyst Hose Assemblies (FRP)	5-21

6. FITTINGS

Adapters	6-2
Swivel Connections	6-2
Swivel Adapters	6-3
Swivel Unions	6-3
Bulkhead Union Elbows	6-3
Reducing Bushings	6-4
Nipples & Reducing Nipples	6-4
Elbows	6-7
Misc. Connections	6-8
Tees & Crosses	6-8
Pipe Plugs	6-9
Quick Disconnects	6-10

7. AIR SUPPLY CONTROLS & GAUGES

Air Regulators	7-2
Bypass Air Regulators	7-4
Centrifugal Air Filters / Regulators	7-6
Coalescer Units	7-8
Desiccant Units	7-10
1 Stage Charcoal Filter	7-12
3 Stage Breathing Air Unit	7-12
2 Stage Filter / Regulator	7-12
Filter Element Kits	7-14
Air Vizor™ Breathable Air Systems	7-14
Valves	7-15
Air Pressure Gauges	7-16

8. CUPS, CUP ACCESSORIES & MISC. PRODUCTS

Siphon Cups	8-2
Pressure Cups	8-3
Gravity Feed Cups	8-4
Remote Pressure Cups	8-5
Cup Accessories	8-6
Misc. Products	8-7

Pump Mounting Hardware & Accessories

PUMP MOUNTING HARDWARE	1-2
PUMP CARTS & STANDS	1-3
BUNG ADAPTERS	1-3
PAIL & DRUM COVERS	1-4
DRUM ELEVATOR	1-5
GROUND WIRE KITS	1-5
AIR LINE LUBRICATORS	1-5
PUMP PROTECTORS / AIR RUNAWAY VALVES	1-5
AIR MOTOR MUFFLERS	1-6
GUN/OUTLET MANIFOLDS	1-6
SIPHON HOSES / SETS (5 & 10 GALLON)	1-7
SIPHON HOSES / SETS (55 GALLON)	1-8

Pump Mounting Hardware & Accessories

Pump Wall Mounting Brackets

Part Number	Pump Style	Materials of Construction	Used with Air Motor	Misc Info
873184	Infinity	Painted black carbon steel	2", N Series and 4-1/4"	2" npt(f) threaded hole, open 55 gal. Rim mount
873115	Infinity	Painted black carbon steel	4-1/4", 6" 2 and 4 ball and 1" Diaphragm Pumps	Full hole cut-out
873134	Infinity	Painted black carbon steel	3:1 Diaphragm Pumps	4 bolt, full hole cut-out (not shown)
873237	Infinity	Painted black carbon steel	8" Air Motors	4 bolt, full hole cut-out (not shown)
873116	Infinity & Gemini 1/2"	Painted black carbon steel	N Series and 1/2" Diaphragm pumps	4 bolt, full hole cut-out
873189	Infinity	Painted black carbon steel	12" Air Motors	4 bolt, full hole cut-out (not shown)
873461	Infinity	Painted black carbon steel	Raptor, Vector 8122XX and 8126XX series pumps	4 bolt, full hole cut-out, with air reg. mnt. holes (not shown)
41-10705	Comet	Painted blue carbon steel	Comet 3 and 4" Air Motors	3 bolt, v cut. Holes for air reg. kit and bpr. or fltr.
207-12328	Exel	Unpainted zinc plated steel	Exel	4 hole for air mtr, 2 hole for mounting (2 Req'd)
0114-014806	Comet 4/12	Painted black carbon steel	Comet 4/12	4 bolt, full cut hole
DVP-50	DVP	Painted black carbon steel	Single Diaphragm Pump	(not shown)
41-28047	BX	Powder coated blue carbon steel	B8 and B10 Air Motors	Multiple mounting holes for air mtrs, regulators & heaters, etc
41-28091	BX	Powder coated blue carbon steel	B8 and B10 Air Motors	Multiple mounting holes for air motors, regulators & heaters, etc., air control

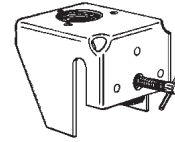

873184

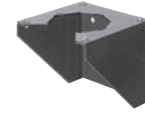

873115



873116

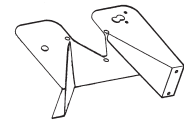

41-10705

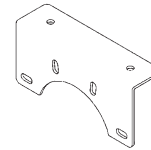

207-12328



0114-014806

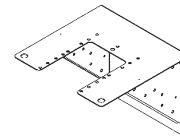

41-28047

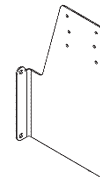

41-28091

Post Mount Mounting Bracket

Part Number	Pump Style	Materials of Construction	Used with Air Motor	Misc Info
873185	Infinity	Black painted carbon steel	4-1/4", 6" and 8"	Floor standing post



873185

Pump Mounting Hardware & Accessories

Pump Carts & Stands

Part Number	Pump Style	Materials of Construction	Used with Air Motor	Misc Info
873186	Infinity	Black painted carbon steel	4-1/4" and 6" 2 ball Infinity pumps	Large pneumatic tires
41-28050	BX	Blue painted carbon steel	BX-36 and BX-57 pumps	Large pneumatic tires
41-2208	Comet	Blue painted steel bracket with chrome plated, tubular steel cart	Comet 3" and 4" 18:1 and 30:1 pumps	Semi-pneumatic tires
0114-019203	Comet 4/12	Black, painted carbon steel	Comet 4/12 pumps	Semi-pneumatic tires
0110-011802	Comet 4/12	Aluminum	Comet 4/12 pumps	Tripod stand with plate



873186

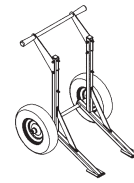

41-28050

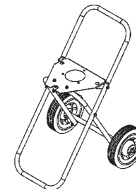

41-2208



0114-019203



0110-011802

Threaded Bung Adapter

Part Number	Materials of Construction	Misc Info
873227	Cast aluminum and steel	Threaded for 2" bung drum thread and used on Pogo series pumps. With thumb screw.



873227

Bunghole Adapter Kits

Part Number	Materials of Construction	Misc Info
41-15899*	Stainless steel	With lockwasher, set screw and locknut. For 1/2" siphon tubes (7/8" o.d.).
41-15898*	Stainless steel	With lockwasher, set screw and locknut. For 3/4" siphon tubes (1-1/8" o.d.).
41-15895*	Steel	With lockwasher, set screw and locknut. For 1" siphon tubes (1-11/32" o.d.).
207-11692-1	Cast aluminum	1" siphon tube bung adapter. Requires 237-621 thumbscrew. (not shown)



41-15895, 41-15898, 41-15899

*41-755 spacer and 20-2454 nut are included (not shown)

Pump Mounting Hardware & Accessories

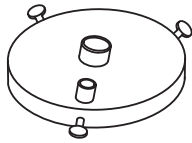

874502

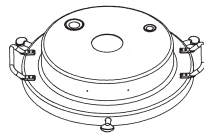

41-3205

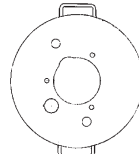

41-2455

5 Gallon Pail Covers

Part Number	Pump Style	Materials of Construction	Used with	Misc Info	Service Form
874502	Infinity	Stainless steel	843000 Agitator	5 Gal. Cover for 1/2" siphon tube	n/a
874503	Infinity, Gemini 1/2"	Stainless steel	1/2" Diaphragm pumps	Has agitator hole in cover. For 5 Gal Cont. (not shown)	n/a
41-3205	Binks, Comet	Zinc chromate plated steel	Agitators / Pogo pumps	With agitator, pump and siphon (5 Gal.)	77-1470
41-2455	Binks, Comet	Zinc chromate plated steel	Comet 18:1 and 30:1 pump outfits	With agitator hole and 2, 7/8" holes for regs or return (5 Gal.)	n/a

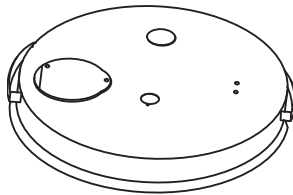

31-124

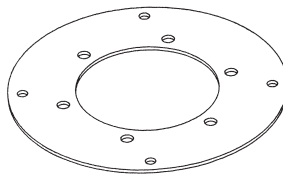

41-11499

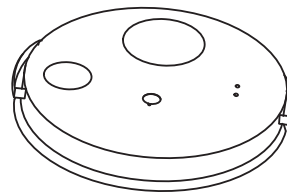

41-2414

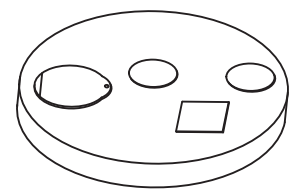

874506

55 Gallon Drum Covers

Part Number	Pump Style	Materials of Construction	Used with	Misc Info	Service Form
874506	Infinity, Gemini 1/2"	Stainless steel	1/2" Diaphragm pumps and bung mntd. piston pumps such as 812490, pogo pumps	With insp.port, agitator hole and hole for pump or bung mount (55 Gal.)	n/a
31-124	Binks, Comet	Zinc chromate plated steel	55 Gal direct drive agitator	With insp.port, agitator hole and siphon tube hole	77-1481
41-11499	Binks, Comet	Zinc chromate plated steel	Comet 2.5:1 High-Vol	Used to adapt to 41-2414 55 gal drum cover	n/a
41-2414	Binks, Comet	Zinc chromate plated steel	Comet 2.5:1 High-Vol	With agitator & inspection ports (55 Gal.)	n/a

Pump Mounting Hardware & Accessories

Drum Elevator

Part Number	Lift Capacity	Misc Info	Shipping Weight	Service Form
41-9000	235 lbs @ 60 psi 395 lbs @ 100 psi	Comes with air control valve, 10 ft. of air tubing, mounting brackets and hardware. Floor mounting anchors and drum cover are not included. Use with 31-129 and 31-397 agitator assemblies.	68 lbs	77-1392



41-9000

Ground Wire Kits

Part Number	Description	Misc Info
873067	Ground wire assy.	25 ft heavy duty sheathed wire with screw type clamp on one end and large ring terminal on the other.
41-13021	Ground wire assy.	8 ft long 18 gauge with small alligator clamp on one end and large ring terminal on the other.
0114-016243	Ground wire assy.	For use with Comet 4/12 pumps. (not shown)



873067

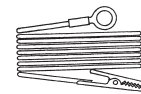

41-13021

Air Line Lubricators

Part Number	Used on	Port Sizes	cfm Rating	Oil Capacity	Misc Info	Service Form
849304	Infinity	1/2" npt(f)	110 scfm	6oz/177ml	Metal bowl Inc. sight glass. / 175 Deg. F / 150 psi	849304
849310					Lubricator connector kit	
237-578	Binks	1/2" npt(f)	110 scfm	8oz/237ml	Zinc bowl Inc. sight glass. / 150 Deg. F / 250 psi	n/a

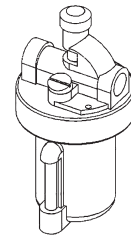

237-578

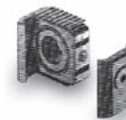

849310

Pump Protectors / Air Runaway Valves

Part Number	Pumps used on	cfm Range	Pressure Range	Service Form
41-11150	Binks B series / Infinity	0-150 cfm	0-125 psi	77-2257
41-11260	Binks Comet	.5-4.5 cfm	25-100 psi	77-2416

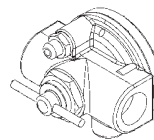

41-11150

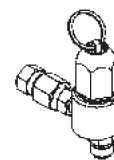

41-11260

Pump Mounting Hardware & Accessories



873158



873190

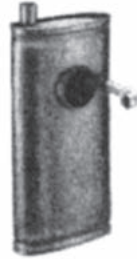

873364



237-536



83-1527, 350-401

Air Motor Mufflers

Part Number	Pump Style	Air Inlet Size	Dimensions	Misc Info
873158	Infinity 4-1/4" and 6" air motors	1-1/4" male, npt	3-1/2" x 11-3/16"	Used with 4-1/4" and 6" air motor pumps
873190	Infinity 8" air motors	1-1/4" male, npt	5-5/8 x 15-3/8"	Used with 8" air motor pumps
873364	Infinity 12" air motor	Bolted On	9" x 20"	Used with Infinity 12" air motors
237-536	Exel / Unison Pumps	1/2" male, npt	3-1/8" x 1-1/4"	Aluminum, 50M stn stl screen
83-1527	Air Motor Agitators	1/4" male, npt	1-5/8" x 1-3/4"	Steel body, felt muffer
350-401	Air Motor Agitators	1/4" male, npt	1-5/8" x 1-3/4"	Steel body, felt muffer

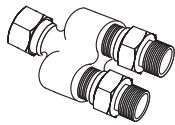

72-1823

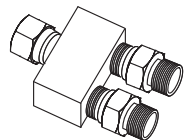

72-1927

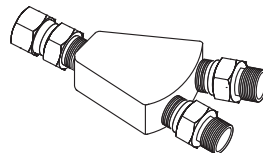

111-1354

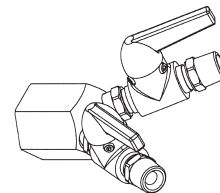

83-2155

Gun/Outlet Manifolds

Part Number	Max. Working Pressure	No. of Outlets	Outlet Threads	Inlet Swivel Nut	Misc Info
72-1823	Low (250 PSI)	2	3/8" nps(m)	3/8" nps(f)	Stainless steel
72-1927	Low (250 PSI)	2	1/4" nps(m)	1/4" nps(f)	Plated brass fittings, plated steel body and swivel nut
111-1354	High (3000 PSI)	2	1/4" nps(m)	1/4" nps(f)	Used in circulating and heated fluid systems
83-2155	High (4000 PSI)	2	3/8" npt(m)	1" npt(f)	303 Stainless steel body with 4000 psi valves

Pump Mounting Hardware & Accessories

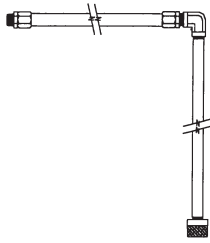

874500

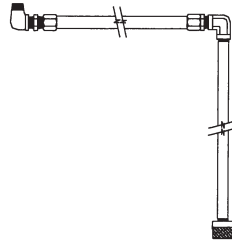

874504

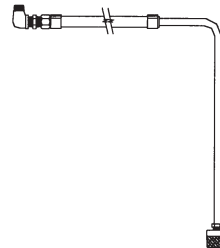

874509

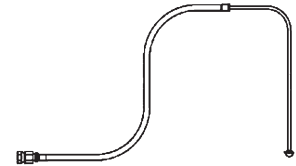

41-17232

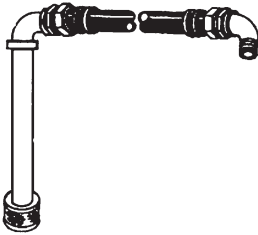

103-1093

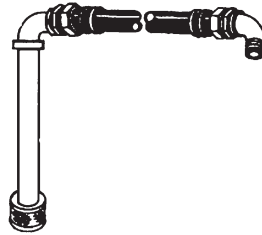

44-350

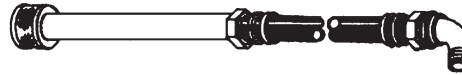

41-2294, 41-2296

Siphon Hoses / Sets (5 & 10 Gallon)

Part Number	Pumps Used with	Hose Size i.d.	Tube Size	Fitting Size	Container Size	Wetted Parts	Service Form
874500	Infinity	1"	3/4"	3/4" male, npt	5 Gallon	Stainless steel	n/a
874504	Infinity	1/2"	1/2"	1/2" male, npt	5 Gallon	Stainless steel	n/a
874509	Infinity	1/2"	1/4"	1/2" male, npt	5 Gallon	Stainless steel	n/a
41-17232	Comet 4/12	3/8"	3/8"	1/2" female, nps	5 Gallon	Stainless steel	77-5461, 77-5462, 77-5463
103-1093	Binks / Comet	1"	1"	1" male, npt	5 Gallon	Aluminum, steel	77-2126
44-350	Binks / Comet	3/4"	3/4"	3/4" male, npt	5 Gallon	Stainless steel	77-2098
41-2294	Binks / Comet	3/4"	3/4"	3/4" male, npt	5&10 Gallon	Aluminum, steel	77-2098
41-2296	Binks / Comet	1"	1"	1" male, npt	5&10 Gallon	Aluminum, steel	77-2098

Pump Mounting Hardware & Accessories

1

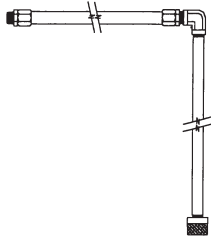

874501

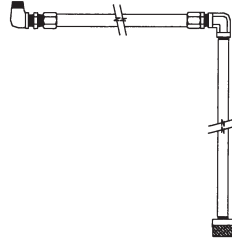

874580

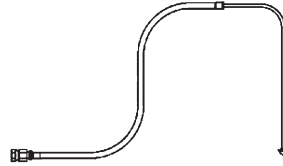

41-17233

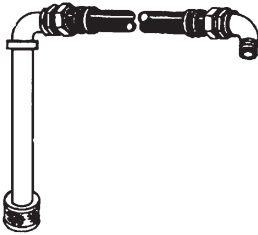

103-1068, 41-2616, 41-10467

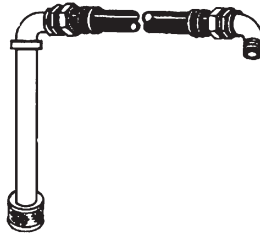

44-155, 44-355

Siphon Hoses / Sets (55 Gallon)

Part Number	Pumps Used with	Hose Size i.d.	Tube Size	Fitting Size	Container Size	Wetted Parts	Service Form
874501	Infinity	1"	3/4"	3/4" male, npt	55 Gallon	Stainless steel	n/a
874580	Infinity	1/2"	1/2"	1/2" male, npt	55 Gallon	Stainless steel	n/a
41-17233	Comet 4/12	3/8"	3/8"	3/4" female, nps	55 Gallon	Stainless steel	77-5461
103-1068	Binks / Comet	1"	1"	1" male, npt	55 Gallon	Aluminum, steel	77-2126
44-155	Binks / Comet	1"	1"	1" male, npt	55 Gallon	Stainless steel	77-2098
44-355	Binks / Comet	1"	3/4"	1" male, npt	55 Gallon	Stainless steel	77-2098
41-2616	Binks / Comet	3/4"	3/4"	3/4" male, npt	55 Gallon	Aluminum, steel	77-2098
41-10467	Binks / Comet	1"	1"	1" male, npt	55 Gallon	Aluminum, steel	77-2098

Fluid Filters, Screens/Strainers, Filter Elements & Filter/Surge Chambers

MATERIAL FILTERS, STRAINERS, SCREENS	2-2
HIGH PRESSURE IN LINE FILTERS	2-3
LOW PRESSURE IN LINE FILTERS	2-3
LOW PRESSURE IN LINE Y STRAINERS	2-4
INLET SCREENS (ROCK CATCHERS)	2-4
GUN MOUNTED MINI STRAINER	2-4
HIGH PRESSURE PUMP FILTER ELEMENTS	2-5
HIGH PRESSURE IN LINE FILTER ELEMENTS	2-5
LOW PRESSURE IN LINE FILTER ELEMENTS	2-5
SURGE CHAMBERS / PULSATION DAMPENERS	2-6

Fluid Filters, Screens/Strainers, Filter Elements & Filter/Surge Chambers

2



841001, 841002,
841005, 841006



841010



103-1241

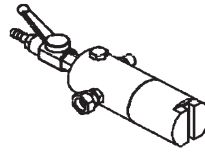

0110-009130

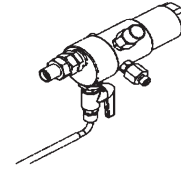

41-12639

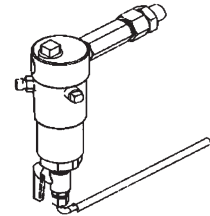

41-12650

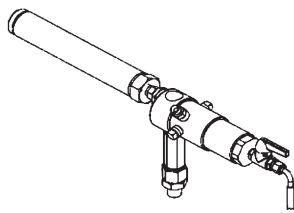

101-1765

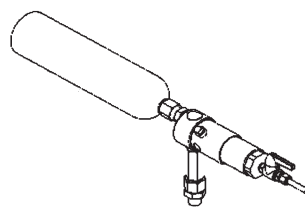

101-2097



207-12259-1,
207-12259-2

Material Filters, Strainers, Screens

Part Number	Description	Inlet Port	Used with	Outlet Port	Mesh	Micron	Materials of Construction	Maximum Working Pressure	Service Form
841001	Material Filter	1/2" npt(f) x2	Infinity	1/2" npt(f)	70	210	Carbon steel	6000 psi	84100X
841002	Material Filter	1/2" npt(f) x2	Infinity	1/2" npt(f)	100	149	Carbon steel	6000 psi	84100X
841005	Material Filter	1/2" npt(f) x2	Infinity	1/2" npt(f)	70	210	Stainless steel	6000 psi	84100X
841006	Material Filter	1/2" npt(f) x2	Infinity	1/2" npt(f)	100	149	Stainless steel	6000 psi	84100X
873188	Outlet adapter to mount 841006 filter	1" npt(m)	Infinity	1/2" npt(m)			Stainless steel	6000 psi	
841010	Material Filter	3/8" npt(f)	Infinity Diaph	3/8" npt(f)	40	420	Nylon, stn stl	150 psi	84101X
103-1241*	Material Filter	3/8" nps(f)	Binks / Comet	1/4" npt(f)	100	149	Stainless steel	4000 psi	77-2015
0110-009130	Material Filter	3/8" bspp(f)	Binks / Comet	1/4" nps(m)	100	149	Stainless steel	7200 psi	77-2890
41-12639	Material Filter	1/2" npt(m)	Binks / Comet	1/4" nps(m)	50	297	Carbon steel	6000 psi	77-2164
41-12650	Material Filter	1/2" npt(m)	Binks / Comet	1/4" nps(m)	50	297	Carbon steel	6000 psi	77-2164
101-1765	Material Filter/ Pulsation Chamber	1/2" npt(m)	Binks / Comet	1/4" nps(m)	50	297	Carbon steel	6000 psi	77-2469
101-2097	Material Filter/ Pulsation Chamber	1/2" npt(m)	Binks / Comet	1/4" nps(m)	50	297	Carbon steel	6000 psi	77-2469
207-12259-1	Material Filter/ Pulsation Chamber	1/2" npt(f)	Binks / Comet	1/2" npt(f)	60	250	Carbon steel/ aluminum	1800 psi	77-2807
207-12259-2	Material Filter/ Pulsation Chamber	1/2" npt(f)	Binks / Comet	1/2" npt(f)	100	149	Carbon steel/ aluminum	1800 psi	77-2807

*Includes 1 ea, 101-9120 1/4" npt(m) x 1/4" npt(m) swivel adapter.

Fluid Filters, Screens/Strainers, Filter Elements & Filter/Surge Chambers

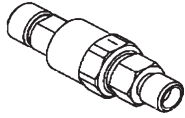

54-4725

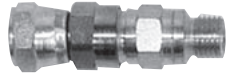

54-3655



54-3656

High Pressure In Line Filters

Part Number	Description	Inlet Port	Used with	Outlet Port	Mesh	Micron	Materials of Construction	Maximum Working Pressure	Service Form
54-4725	In-Line Edge Filter Assy	1/4" nps(m)	Binks	7/16-20 unf 2a thread	100	149	Stainless steel	4000 psi	77-2838
54-3655	In-Line Edge Filter Assy	1/4" nps(m)	Binks	1/4" nps(f)	100	149	Stainless steel	5800 psi	77-5362
54-3656	In-Line Edge Filter Assy/ Swivel	1/4" nps(m)	Binks	1/4" nps(f)	100	149	Stainless steel	5800 psi	77-5362



54-990, 54-981

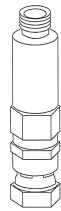

VS-534



VS-531

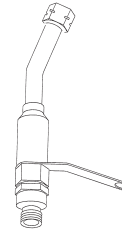

VS-532, 54-988, 54-982

Low Pressure In Line Filters

Part Number	Description	Inlet Port	Used with	Outlet Port	Mesh	Micron	Materials of Construction	Maximum Working Pressure	Service Form
54-990	In line Cartridge Filter	3/8" nps(m)	Binks	3/8" nps(f)	100	149	Plated brass	150 psi	n/a
54-981	In line Cartridge Filter	3/8" nps(m)	Binks	3/8" nps(f)	100	149	Plated brass	150 psi	n/a
VS-534	In line Cartridge Filter	3/8" nps(m)	Devilbiss	3/8" nps(f)	100	149	Stainless steel	300 psi	SB-7-072
VS-531	In line Cartridge Filter	3/8" nps(m)	Devilbiss	3/8" nps(f)	100	149	Carbon steel	300 psi	SB-7-072
VS-532	In line Cartridge Filter	3/8" nps(m)	Devilbiss	3/8" nps(f)	100	149	Plated brass	300 psi	SB-7-072
54-988	In line Cartridge Filter	3/8" nps(m)	Binks	3/8" nps(f)	100	149	Plated brass	150 psi	n/a
54-982	In line Cartridge Filter	3/8" nps(m)	Binks	3/8" nps(f)	100	149	Plated brass	150 psi	n/a

Fluid Filters, Screens/Strainers, Filter Elements & Filter/Surge Chambers

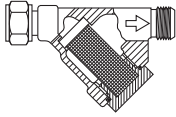

Low Pressure In Line Y-Strainers

Part Number	Description	Inlet Port	Used with	Outlet Port	Mesh	Micron	Materials of Construction	Maximum Working Pressure	Service Form
83-2922	In Line Filter	3/8"nps(f)	Binks	3/8"nps(m)	50	297	Plated brass / Stainless steel	200 psi	77-2394
83-2923	In Line Filter	3/8"nps(f)	Binks	3/8"nps(m)	80	177	Plated brass / Stainless steel	200 psi	77-2394
83-2924	In Line Filter	3/8"nps(f)	Binks	3/8"nps(m)	100	149	Plated brass / Stainless steel	200 psi	77-2394
83-2925	In Line Filter	3/8"nps(f)	Binks	3/8"nps(m)	150	96	Plated brass / Stainless steel	200 psi	77-2394
83-2926	In Line Filter	3/8"nps(f)	Binks	3/8"nps(m)	200	74	Plated brass / Stainless steel	200 psi	77-2394



101-142, 41-10094,
41-2661, 41-2662, 41-2663



873192, 873117



41-17234-10



41-2288

Inlet Screens (Rock Catchers)

Part Number	Thread Size	Materials of Construction	Mesh Size	Pumps used with
101-142	1" npt(f)	Stainless steel	8/16	Comets B,C,D
41-10094	3/4" npt(f)	Stainless steel	16	Comets B,C,D
41-2661	1/2" npt(f)	Stainless steel	30	Comets B,C,D
41-2662	3/4" npt(f)	Stainless steel	30	Comets B,C,D
41-2663	1" npt(f)	Stainless steel	30	Comets B,C,D
873192	3/4" npt(f)	Stainless steel	30	Infinity
873117	1/2" npt(f)	Stainless steel	30	Infinity
41-17234-10	Ribbed hole 3/8" o.d. tubing	Rubber/stainless steel	50	Comet 4/12
41-2288	1- 5/8"-12" npt(f)	Stainless steel	30	Comets 3B and 4B
237-755	3/16" or 1/4" i.d. tubing	Polypropylene	75 micron	Unison Catalyst Supply Bottle (not shown)

Gun Mounted Mini Strainer

Part Number	Description	Inlet Port	Used with	Outlet Port	Mesh	Micron	Materials of Construction	Maximum Working Pressure
PLH-MF-6-100	Gun Mounted	3/8"nps(m)	Devilbiss / Binks	3/8"nps(f)	100	149	Stainless steel	250 psi



Fluid Filters, Screens/Strainers, Filter Elements & Filter/Surge Chambers



873146, 873147



83-1256, 83-2089

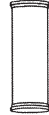

0110-009132

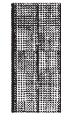

135-77, 135-78



54-980, 54-987



VS-58-K10



83-2405, 83-2596, 83-2705, 83-2706

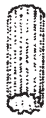

41-2627, 41-2628, 41-2629, 41-2630, 107-1527



207-11693, 207-11694



31144-310-K10



PLH-MFC-100



102-2181

High Pressure Pump Filter Elements

Filter Assembly	Filter Element Standard	Mesh	Filter Element Optional	Mesh
841001	873146	70	873147	100
841002	873147	100	873146	70
841005	873146	70	873147	100
841006	873147	100	873146	70
103-1241	83-1256	100	83-2089	50
0110-009130	0110-009132	100		
41-12650 & 41-12639	41-2629	50	41-2627 41-2628 41-2630 107-1527	100 60 40 20
207-12259-1	207-11693	60	207-11694	100
207-12259-2	207-11694	100	207-11693	60
101-1765 & 101-2097	41-2629	50	41-2627 41-2628 41-2630 107-1527	100 60 40 20

Low Pressure In Line Filter Elements

Filter Assembly	Filter Element Standard	Mesh	Filter Element Optional	Mesh
841010	135-78	40 x 36	135-77	80 x 80
83-2922	83-2089	50	83-2705	30
83-2923	83-2596	80	83-2705	30
83-2924	83-1256	100	83-2705	30
83-2925	83-2405	150	83-2705	30
83-2926	83-2706	200	83-2705	30
54-990	54-987	100		
54-991	54-980	150		
54-988	54-987	100		
54-982	54-980	150		
VS-532	VS-58-K10	100		
VS-534	VS-58-K10	100		
VS-531	31144-310-K10	100		
PLH-MF-6-100	PLH-MFC-100	100		
	102-2181	200		



54-1835, 54-1836

High Pressure In Line Filter Elements

Filter Assembly	Filter Element Standard	Mesh	Filter Element Optional	Mesh
54-4725	54-1835	100	54-1836	60
54-3655	54-1835	100	54-1836	60
54-3656	54-1835	100	54-1836	60

Fluid Filters, Screens/Strainers, Filter Elements & Filter/Surge Chambers

2



844000



873193



873067



41-1020



237-847

Surge Chambers / Pulsation Dampeners



Part Number	Pressure Range	Fitting Sizes	Wetted Parts	Misc Info	Service Form
844000	0-100 psi	1" npt(f) fittings	Conductive acetal and teflon	Reduces pulsation by up to 97%. Helps reduce foaming and hydraulic shock. 873067 Grounding Kit.	844000
873193	n/a	n/a	n/a	Mounting Base for the 844000	844000
873067	n/a	n/a	n/a	Grounding Kit for 844000	840000
41-1020	0-4000 psi	3/8" npt(f)	Plated steel, painted blue exterior	Surge bottle only	77-2469
237-847	0-1800 psi	3/4-16-unf-2b	Aluminum	Surge bottle only	77-2807

Fluid Regulators, Gauges & Heaters

FLUID REGULATORS	3-2
BACK PRESSURE FLUID REGULATORS	3-6
GUN MOUNT NON-CIRCULATING REGULATORS	3-10
GUN MOUNT CIRCULATING REGULATORS	3-10
FLUID REGULATOR KITS	3-12
PRESSURE GAUGES	3-13
FLUID HEATERS & FRP HEATER KITS	3-14

Fluid Regulators, Gauges & Heaters

Low Pressure Fluid Regulators

	Part Number	Wetted Parts	Inlet	Outlet	Inlet Pressure Min.	Inlet Pressure Max.	Outlet Pressure Min.	Outlet Pressure Max.
	For Ceramic Glaze							
	84-120	Nickel Plated Brass	3/8"npt(m)	3/8"nps(m)	n/a	100 psi / 7 bar	5 psi / .35 bar	40 psi / 2.7 bar
	HGB-502-1	Stainless steel	3/8"npt(f)	(2) 3/8"npt(f)	50 psi / 3.5 bar	175 psi / 12 bar	10 psi / .7 bar	75 psi / 5 bar
	HGB-508-1	Stainless steel	3/8"nps(f)	3/8"nps(m) / 3/8"npt(f)	50 psi / 3.5 bar	175 psi / 12 bar	10 psi / .7 bar	75 psi / 5 bar
	HGB-509-5-R38	Stainless steel	3/8bsp(f)	3/8"nps / bsp(m)	30 psi / 2 bar	180 psi / 12.5 bar		75 psi / 5 bar
	HGB-609-1.2-R38	Stainless steel	3/8"bsp(f)	3/8"nps / bsp(m)	15 psi / 1 bar	115 psi / 8 bar		35 psi / 2.5 bar
	HGB-609-5-R38	Stainless steel	3/8"bsp(f)	3/8"nps / bsp(m)	30 psi / 2 bar	175 psi / 12 bar		75 psi / 5 bar
	HGB-609-9-R38	Stainless steel	3/8"bsp(f)	3/8"nps / bsp(m)	45 psi / 3 bar	215 psi / 15 bar		130 psi / 9 bar
	84-410	Stainless steel	3/8"npt(f)	3/8"nps(m) / 3/8"npt(f)		100 psi / 7 bar	1 psi / .1 bar	12 psi / 1 bar
	84-320	Stainless steel	3/8"npt(m)	3/8"nps(m)		200 psi / 14 bar	5 psi / .3 bar	55 psi / 4 bar
	84-407	Stainless steel	3/8"npt(f)	3/8"nps(m)		200 psi / 14 bar	5 psi / .3 bar	55 psi / 4 bar
	84-409	Stainless steel	3/8"npt(m)	3/8"nps(m) / 3/8"npt(f)		200 psi / 14 bar	5 psi / .3 bar	100 psi / 7 bar
	84-346	Zinc plated	3/8"npt(m)	3/8"nps(m) / 1/4"npt(f)		100 psi / 7 bar	1 psi / .1 bar	12 psi / 1 bar
	84-345	Zinc plated	3/8"npt(m)	3/8"nps(m)		200 psi / 14 bar	5 psi / .3 bar	55 psi / 4 bar
	84-411	Zinc plated	3/8"npt(m)	3/8"nps(m)		200 psi / 14 bar	5 psi / .3 bar	100 psi / 7 bar
	84-412	Zinc plated	3/8"npt(m)	3/8"nps(m)		200 psi / 14 bar	5 psi / .3 bar	100 psi / 7 bar

Fluid Regulators, Gauges & Heaters



Low Pressure Fluid Regulators

Part Number	Capacity	Type	Gauge	Service Forms
For Ceramic Glaze				
84-120	1 gpm / 3.8 lpm	Key	83-1355 gauge 100 / 0-7 bar	77-1417
HGB-502-1	8 gpm / 30 lpm	Key (adaptable to remote)	None	SB-6-375
HGB-508-1	8 gpm / 30 lpm	Key (adaptable to remote)	HGB-14 riser tube & 83-2727 gauge 100 psi / 6.5 bar	SB-6-375
HGB-509-5-R38	3.4 gpm / 13 lpm	Key	None	SB-6-HGB-H
HGB-609-1.2-R38	2.2 gpm / 8.3 lpm	Key	MA-25 gauge 35 psi / 2.5 bar	SB-6-HGB-H
HGB-609-5-R38	3.4 gpm / 13 lpm	Key	GA-333 gauge 100 psi / 7 bar	SB-6-HGB-H
HGB-609-9-R38	3.4 gpm / 13 lpm	Key	GA-288 gauge 160 psi / 11 bar	SB-6-HGB-H
84-410	12 oz/Min. / .4 lpm	Key (adaptable to remote)	84-348 riser tube & 83-1414 gauge 30 psi / 2 bar	77-1921
84-320	1 gpm / 3.8 lpm	Key (adaptable to remote)	84-348 riser tube & 83-2571 gauge 100 psi / 6.5 bar	77-1486
84-407	1 gpm / 3.8 lpm	Remote operated	84-348 riser tube & 83-2571 gauge 100 psi / 6.5 bar	77-1486
84-409	1 gpm / 3.8 lpm	Key (adaptable to remote)	84-348 riser tube & 83-2571 gauge 100 psi / 6.5 bar	77-1915
84-346	12 oz/Min. / .4 lpm	Key (adaptable to remote)	84-40 connection & 83-1636 gauge 15 psi / 1 bar	77-1758
84-345	1 gpm / 3.8 lpm	Key (adaptable to remote)	84-40 connection & 83-1355 gauge 100 psi / 6.5 bar	77-1632
84-411	1 gpm / 3.8 lpm*	Key (adaptable to remote)	84-40 connection & 83-1355 gauge 100 psi / 6.5 bar	77-2011
84-412	1 gpm / 3.8 lpm	Key (adaptable to remote)	84-40 connection & 83-1290 gauge 150 psi / 10 bar	77-1632

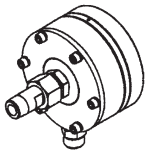

* For high viscosity materials 2 gpm / 7.6 lpm for low viscosity

Fluid Regulators, Gauges & Heaters

Low Pressure Fluid Regulators

Part Number	Wetted Parts	Inlet	Outlet	Inlet Pressure Min.	Inlet Pressure Max.	Outlet Pressure Min.	Outlet Pressure Max.
Air pilot							
 84-598	Chrome plated aluminum	3/8"npt(m)	3/8"nps(m)		200 psi / 14 bar	4 psi / .25 bar	100 psi / 7 bar
84-599	Chrome plated aluminum	3/8"npt(m)	3/8"nps(m)		200 psi / 14 bar	4 psi / .25 bar	100 psi / 7 bar
Air pilot							
 HGB-510-R1	Stainless steel	1/4"bsp(f)	1/4"bsp(f)	30 psi / 2 bar	220 psi / 15 bar		220 psi / 15 bar
HGB-510-R2	Stainless steel	1/4"bsp(f)	1/4"bsp(f)	15 psi / 1 bar	220 psi / 15 bar		100 psi / 7 bar
HGB-510-R4	Stainless steel	1/4"bsp(f)	1/4"bsp(f)	15 psi / 1 bar	220 psi / 15 bar		60 psi / 4 bar
HGB-510-R1-CO	Stainless steel	3/8"nps/bsp(m)	1/4"bsp(f)	30 psi / 2 bar	220 psi / 15 bar		220 psi / 15 bar
HGB-510-R2-CO	Stainless steel	3/8"nps/bsp(m)	1/4"bsp(f)	15 psi / 1 bar	220 psi / 15 bar		100 psi / 7 bar
HGB-510-R4-CO	Stainless steel	3/8"nps/bsp(m)	1/4"bsp(f)	15 psi / 1 bar	220 psi / 15 bar		60 psi / 4 bar

Medium Pressure Fluid Regulators

Part Number	Wetted Parts	Inlet	Outlet	Inlet Pressure Min.	Inlet Pressure Max.	Outlet Pressure Min.	Outlet Pressure Max.
 845020	Stainless steel / Tungsten carbide	1-4"npt(f)	(2) 1/4"npt(f)		750 psi / 52 bar	0 psi / 0 bar	30 psi / 2 bar
 845004	Stainless steel / Tungsten carbide	3/8"npt(f)	3/8"npt(f)		750 psi / 52 bar	20 psi / 1.4 bar	60 psi / 4 bar
 845001	Stainless steel / Tungsten carbide	3/8"npt(f)	3/8"npt(f)		1250 psi / 86 bar	100 psi / 7 bar	800 psi / 55 bar

Fluid Regulators, Gauges & Heaters

Low Pressure Fluid Regulators



Part Number	Capacity	Type	Gauge	Service Forms
Air pilot				
84-598	30 oz/Min. / 1 lpm	Remote 1/8"npt(f)	None	77-2871
84-599	100 oz/Min. / 3 lpm	Remote 1/8"npt(f)	None	77-2871
Air pilot				
HGB-510-R1	.42 gpm / 1.6 lpm	Remote (4mm tube)	None	SB-6-HGB-H
HGB-510-R2	.35 gpm / 1.3 lpm	Remote (4mm tube)	None	SB-6-HGB-H
HGB-510-R4	.2 gpm / .8 lpm	Remote (4mm tube)	None	SB-6-HGB-H
HGB-510-R1-CO	.42 gpm / 1.6 lpm	Remote (4mm tube)	None	SB-6-HGB-H
HGB-510-R2-CO	.35 gpm / 1.3 lpm	Remote (4mm tube)	None	SB-6-HGB-H
HGB-510-R4-CO	.2 gpm / .8 lpm	Remote (4mm tube)	None	SB-6-HGB-H

Medium Pressure Fluid Regulators



Part Number	Capacity	Type	Gauge	Service Forms
845020	3 gpm / 11.5 lpm	Hex key wrench	None	845020
845004	6 gpm / 23 lpm	Hex key wrench	Nipple, coupling & gauge 60 psi / 4 bar	84500X
845001	6 gpm / 23 lpm	Hex key wrench	Nipple, coupling & gauge 1000 psi / 70 bar	84500X

Fluid Regulators, Gauges & Heaters

High Pressure Fluid Regulators

	Part Number	Wetted Parts	Inlet	Outlet	Inlet Pressure Min.	Inlet Pressure Max.	Outlet Pressure Min.	Outlet Pressure Max.
	845014	Carbon Steel / Tungsten carbide	3/8"npt(f)	3/8"npt(f)		3000 psi / 207 bar	400 psi / 28 bar	1250 psi / 86 bar
	845011	Stainless steel / Tungsten carbide	3/8"npt(f)	3/8"npt(f)		6000 psi / 414 bar	1000 psi / 70 bar	3000 psi / 207 bar
	845013	Stainless steel / Tungsten carbide	3/8"npt(f)	3/8"npt(f)		6000 psi / 414 bar	2000 psi / 140 bar	5000 psi / 345 bar
	845010	Stainless steel / Tungsten carbide	3/8"npt(f)	3/8"npt(f)		3000 psi / 207 bar	400 psi / 28 bar	1250 psi / 86 bar
	84-420	Stainless steel	1-4"npt(m)	1/4"npt(f)		3000 psi / 210 bar	300 psi / 21 bar	2000 psi / 139 bar
	84-520	Stainless steel	1-4"npt(m)	1/4"npt(f)		2000 psi / 140 bar	100 psi / 7 bar	900 psi / 62 bar

Back Pressure Regulators (Low Pressure)

	Part Number	Wetted Parts	Inlet	Outlet	Inlet Pressure Min.	Inlet Pressure Max.	Outlet Pressure Min.	Outlet Pressure Max.
	84-501	Electroless nickel plated	1/2"npt(f)	1/2"npt(f)		150 psi / 10 bar	10 psi / .7 bar	140 psi / 10 bar
	84-404	Stainless steel	3/4npt(f)	3/4npt(f)		150 psi / 10 bar	10 psi / .7 bar	140 psi / 10 bar
	84-504	Stainless steel	1-1/4"npt(f)	1-1/4"npt(f)		150 psi / 10 bar	10 psi / .7 bar	140 psi / 10 bar
	84-601	Stainless steel (low shear)	1/2"npt(f)	1/2"npt(f)		200 psi / 14 bar	0 psi / 0 bar	130 psi / 9 bar
	845000	Stainless steel	3/8"npt(f)	3/8"npt(f)		200 psi / 14 bar	0 psi / 0 bar	200 psi / 14 bar
	845003	Stainless steel	1-1/4"npt(f)	1-1/4"npt(f)		200 psi / 14 bar	0 psi / 0 bar	200 psi / 14 bar
	HGBR-609	Stainless steel	1/4"npt(f)	1/4"npt(f)	30 psi / 2 bar	180 psi / 12.5 bar	0 psi / 0 bar	130 psi / 9 bar

Fluid Regulators, Gauges & Heaters

High Pressure Fluid Regulators

Part Number	Capacity	Type	Gauge	Service Forms
845014	3 gpm / 11.5 lpm	Hex key wrench	None	845010
845011	3 gpm / 11.5 lpm	Hex key wrench	None	84501X
845013	6 gpm / 23 lpm	Hex key wrench	None	84501X
845010	3 gpm / 11.5 lpm	Hex key wrench	None	84501X
84-420	1 gpm / 3.8 lpm	T- handle	Optional gauge 101-3069 3000 psi / 207 bar	77-1908
84-520	1 gpm / 3.8 lpm	T- handle	Optional gauge 84-491 1000 psi / 70 bar	77-1908

Back Pressure Regulators (Low Pressure)



Part Number	Capacity	Type	Gauge	Service Forms
84-501	7 gpm / 26 lpm	Key	Optional 84-40 connection & 83-1290 gauge 150 psi / 10 bar	77-1662
84-404	11 gpm / 42 lpm	Key	Optional 84-348 riser tube & 83-2744 gauge 200 psi / 13 bar	77-1889
84-504	11 gpm / 42 lpm	Key	Optional 84-348 riser tube & 83-2744 gauge 200 psi / 13 bar	77-1889
84-601	1 gpm / 3.8 lpm	Key	84-348 riser tube & 83-2744 gauge 200 psi / 13 bar	77-2677
845000	6 gpm / 23 lpm	Hex key	Nipple, coupling & gauge 300 psi / 21 bar	84500X
845003	18.5 gpm / 70 lpm	Hex key	Nipple, coupling & gauge 300 psi / 21 bar	84500X
HGBR-609	4.9 gpm / 18 lpm	Key	Riser tube & gauge GA-288 160 psi / 11 bar	SB-6-HGBR-A

Fluid Regulators, Gauges & Heaters

Back Pressure Regulators (Medium Pressure)

	Part Number	Wetted Parts	Inlet	Outlet	Inlet Pressure Min.	Inlet Pressure Max.	Outlet Pressure Min.	Outlet Pressure Max.
	845002	Stainless steel	3/8"npt(f)	3/8"npt(f)		800 psi / 55 bar	0 psi / 0 bar	800 psi / 55 bar

Back Pressure Regulators (High Pressure)

	Part Number	Wetted Parts	Inlet	Outlet	Inlet Pressure Min.	Inlet Pressure Max.	Outlet Pressure Min.	Outlet Pressure Max.
	845020	Stainless steel / Tungsten carbide	1-4"npt(f)	(2) 1/4"npt(f)		750 psi / 52 bar	0 psi / 0 bar	30 psi / 2 bar
	84-421	Stainless steel	1/4"npt(f)	1/4"npt(m)		3000 psi / 207 bar	100 psi / 7 bar	2000 psi / 140 bar
	845012	Stainless steel	3/8"npt(f)	3/8"npt(f)		3000 psi / 207 bar	100 psi / 7 bar	3000 psi / 207 bar

Fluid Regulators, Gauges & Heaters

Back Pressure Regulators (Medium Pressure)

Part Number	Capacity	Type	Gauge	Service Forms
845002	6 gpm / 23 lpm	Hex key	Nipple, coupling & gauge 1000 psi / 70 bar	84500X

Back Pressure Regulators (High Pressure)

Part Number	Capacity	Type	Gauge	Service Forms
845020	3 gpm / 11.5 lpm	Allen wrench	None	845020
84-421	1 gpm / 3.8 lpm	T- handle	Optional 101-3069 gauge 3000 psi / 207 bar	77-1909
845012	6 gpm / 23 lpm	Hex key	None	84501X

3

Fluid Regulators, Gauges & Heaters

Gun Mount Non-Circulating Regulators

Part Number	Description / Wetted Parts	Inlet	Outlet	Inlet Press. Min.	Inlet Press. Max.	Outlet Press. Min.	Outlet Press. Max.
84-585	Stainless steel low pressure	1/4" nps(m)	3/8" nps(f) sw	n/a	250 psi	0 psi	50 psi
HGS-5132	Stainless steel low pressure	1/8" npt(f)	3/8" nps(f) sw	50 psi	300 psi	2 psi	100 psi
HGS-5133	Stainless steel low pressure	1/8" npt(f)	1/4" nps(m) standpipe	50 psi	300 psi	2 psi	100 psi
HGS-5231	Stainless steel low pressure	1/8" npt(f)	Bayonet lock (q.d.)	50 psi	300 psi	2 psi	100 psi
HGS-5232	Stainless steel low pressure	1/8" npt(f)	3/8" nps(f) swivel	50 psi	300 psi	2 psi	100 psi
HGS-5233	Stainless steel low pressure	1/8" npt(f)	1/4" nps(m) standpipe	50 psi	300 psi	2 psi	100 psi
HGS-5239	Stainless steel low pressure	3/8" nps(f)	3/8" nps(m)	50 psi	300 psi	2 psi	100 psi
HGS-5242	Stainless steel	3/8" nps(m)	3/8" nps(f) sw	50 psi	300 psi	2 psi	100 psi

Gun Mount Circulating Regulators

Part Number	Description / Wetted Parts	Inlet	Outlet	Inlet Press. Min.	Inlet Press. Max.	Outlet Press. Min.	Outlet Press. Max.
84-525	Stainless steel	1/4" nps(m)	3/8" nps(f) sw/ 1/4" nps(m)	n/a	250 psi	0 psi	50 psi
HGS-5112	Stainless steel	1/4" nps(m)	3/8" nps(f) sw	50 psi	300 psi	2 psi	100 psi
HGS-5113	Stainless steel	1/4" nps(m)	1/4" nps(m) standpipe	50 psi	300 psi	2 psi	100 psi
HGS-5122	Stainless steel	3/8" nps(m)	3/8" nps(f) sw	50 psi	300 psi	2 psi	100 psi
HGS-5211	Stainless steel	1/4" nps(m)	Bayonet lock (q.d.)	50 psi	300 psi	2 psi	100 psi
HGS-5212	Stainless steel	1/4" nps(m)	3/8" nps(f) sw	50 psi	300 psi	2 psi	100 psi
HGS-5221	Stainless steel	3/8" nps(m)	Bayonet lock (q.d.)	50 psi	300 psi	2 psi	100 psi
HGS-5222	Stainless steel	3/8" nps(m) x 2	3/8" nps(f) sw	50 psi	300 psi	2 psi	100 psi
HGS-5313	Stainless steel	1/4" nps(m)	1/4" nps(m) standpipe	50 psi	300 psi	2 psi	100 psi
84-261	s.s. Circulating Conn w/ Restrictor	3/8" nps(m)	3/8" nps(f) sw	0 psi 0 bar	200 psi	n/a	n/a
72-1823	s.s. Circulating Conn.	3/8" nps(m) x 2	3/8" nps(f)	0 psi 0 bar	200 psi	n/a	n/a

Fluid Regulators, Gauges & Heaters

Gun Mount Non-Circulating Regulators

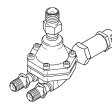

Style 5A

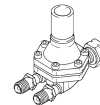

Style 5B

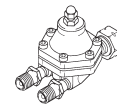

Style 5C



Style 13B



Part Number	Capacity	Type	Gauge	Style*	Service Forms
84-585	n/a	Manually adjusted	None	13B	77-2594
HGS-5132	2500 ml /min	Air pilot (remote)	None	5A,B & C	SB-6-403
HGS-5133	2500 ml /min	Air pilot (remote)	None	5A,B & C	SB-6-403
HGS-5231	2500 ml /min	Manual	None	5A,B & C	SB-6-403
HGS-5232	2500 ml /min	Manual	None	5A,B & C	SB-6-403
HGS-5233	2500 ml /min	Manual	None	5A,B & C	SB-6-403
HGS-5239	2500 ml /min	Manual	None	5A,B & C	SB-6-403
HGS-5242	2500 ml /min	Manual	None	5A,B & C	SB-6-403

Gun Mount Circulating Regulators

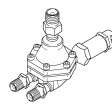

Style 5A

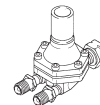

Style 5B

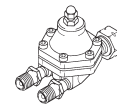

Style 5C



Style 13B



Part Number	Capacity	Type	Gauge	Style*	Service Forms
84-525	1/2 GPM	Spray gun mount	None	13B	77-2594
HGS-5112	2500 ml /min	Air pilot (remote)	None	5A,B & C	SB-6-403
HGS-5113	2500 ml /min	Air pilot (remote)	None	5A,B & C	SB-6-403
HGS-5122	2500 ml /min	Air pilot (remote)	None	5A,B & C	SB-6-403
HGS-5211	2500 ml /min	Manual	None	5A,B & C	SB-6-403
HGS-5212	2500 ml /min	Manual	None	5A,B & C	SB-6-403
HGS-5221	2500 ml /min	Manual	None	5A,B & C	SB-6-403
HGS-5222	2500 ml /min	Manual	None	5A,B & C	SB-6-403
HGS-5313	2500 ml /min	Manual tamper resistant	None	5A,B & C	SB-6-403
84-261	n/a	n/a	None	n/a	77-2096
72-1823	n/a	n/a	None	n/a	n/a

Fluid Regulators, Gauges & Heaters

Fluid Regulator Repair Kits

Regulator Part No.	Repair Kit	Diaphragm Kit	Valve & Seat Kit	Part Sheet
84-120	n/a	n/a	n/a	77-1417
84-320	6-1310	n/a	n/a	77-1486
84-345	6-221	n/a	n/a	77-1632
84-346	84-591	84-592	n/a	77-1758
84-404	n/a	6-1310	6-1312	77-1889
84-407	6-1310	n/a	n/a	77-1486
84-409	6-210	n/a	n/a	77-1915
84-410	84-591	84-592	n/a	77-1921
84-411	6-210	n/a	n/a	77-2011
84-412	6-221	n/a	n/a	77-1632
84-415	84-591	84-592	n/a	77-1758
84-420	6-1306	n/a	n/a	77-1908
84-421	6-1306	n/a	n/a	77-1909
84-501	n/a	6-1310	6-1311	77-1662
84-504	n/a	6-1310	6-1312	77-1889
84-520	6-1306	n/a	n/a	77-1908
84-525	n/a	6-1305	n/a	77-2594
84-585	n/a	6-1305	n/a	77-2689
84-598	6-525	6-525	6-525	77-2871
84-599	6-526	6-526	6-526	77-2871
84-601	n/a	6-1309	n/a	77-2629
845000	6-1306	n/a	n/a	77-1909
845001	863010	863003	863005	84500X
845002	6-1306	n/a	n/a	77-1909
845003	863012	863003	863004	84500X
845004	863018	863003	863007	84500X
845010	863013	863008	863007	84501X
845011	863013	863008	863007	84501X

Fluid Regulator Repair Kits

Regulator Part No.	Repair Kit	Diaphragm Kit	Valve & Seat Kit	Part Sheet
845012	863011	863003	863001	84500X
845013	863015	863008	863005	84501X
845014	863013	863008	863007	84501X
845020	n/a	n/a	n/a	845020
HGB-502-1	n/a	KK-4216	HGB-406-4-K	SB-6-375
HGB-508-1	n/a	KK-4216	HGB-406-4-K	SB-6-375
HGB-509	n/a	HGB-422	HGB-406-4-K	SB-6-375
HGB-510-R2	n/a	HGB-424	HGB-426	SB-6-HGB-H
HGS-5112	KK-4456	n/a	n/a	SB-6-403
HGS-5113	KK-4456	n/a	n/a	SB-6-403
HGS-5122	KK-4456	n/a	n/a	SB-6-403
HGS-5132	KK-4456	n/a	n/a	SB-6-403
HGS-5133	KK-4456	n/a	n/a	SB-6-403
HGS-5211	KK-4456	n/a	n/a	SB-6-403
HGS-5212	KK-4456	n/a	n/a	SB-6-403
HGS-5221	KK-4456	n/a	n/a	SB-6-403
HGS-5222	KK-4456	n/a	n/a	SB-6-403
HGS-5231	KK-4456	n/a	n/a	SB-6-403
HGS-5232	KK-4456	n/a	n/a	SB-6-403
HGS-5233	KK-4456	n/a	n/a	SB-6-403
HGS-5239	KK-4456	n/a	n/a	SB-6-403
HGS-5242	KK-4456	n/a	n/a	SB-6-403
HGS-5312	KK-4456	n/a	n/a	SB-6-403
HGS-5313	KK-4456	n/a	n/a	SB-6-403
HGS-5321	KK-4456	n/a	n/a	SB-6-403

Fluid Regulators, Gauges & Heaters



GA-288



849306



237-765

Fluid Pressure Gauges

Part No.	Capacity Pressure	Thread Size & Position		Notes
		Bottom	Back	
GA-73	30 psi	1/4" npt(m)		2" Diameter (not shown)
GA-77	30 psi	1/4" npt(m)		3-1/2" Dia. (0-10# Shown in ounces, 10-30 in #s) (not shown)
MA-25	35 psi / 2.5 bar	1/4" bspt		Used on HGB-609-1.2R38 fluid regulators (not shown)
237-765	100 psi		1/8" npt(m)	Stainless steel
849306	160 psi		1/4" npt(m)	Infinity 849303 filter/regulator
GA-288	160 psi	1/4" npt(m)		2" Diameter
84-491	1000 psi	1/4" npt(m)		w / Diaphragm (not shown)
101-3069	3000 psi	1/4" npt(m)		w / Pulse. Diaphragm (not shown)
873055	3000 psi		1/4" npt(m)	Stainless steel

Liquid Filled Stainless Steel

Part No.	Capacity Pressure	Thread Size & Position		Notes
		Bottom	Back	
83-2571	100 psi	1/4" npt(m)		(not shown)
107-1433	2000 psi	1/4" npt(m)		Used on 101-1950 stainless steel pump assembly (not shown)
107-1637	1000 psi	1/4" npt(m)		(not shown)

Fluid Regulators, Gauges & Heaters

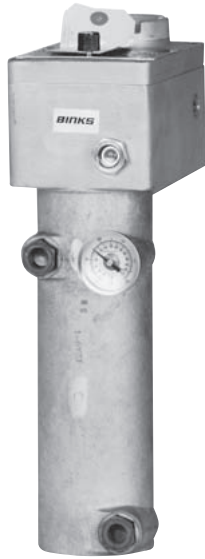

High Pressure, lightweight (18 lbs.), compact and explosion-proof construction. Working capacity to 5000 psi and with adjustable thermostatic control from 60° to 250°F. The typical temperature rise with a flow of 32 fl. oz./min. while maintaining a temperature of 100% above ambient is 100°F. 1/2" npt(f) inlet and outlet ports. (CSA listed, CE approved)

3

Fluid Heaters

Part Number	Max. Working Pressure	Temp Range	Wetted Parts	Voltage	Amperage	Mntg Hdwe	Wattage	Service Form
830000	5000 psi	60 - 250 Deg F	Stainless steel	120 vac	16.6 amps	Included	2000 Watts	83000X
830001	5000 psi	60 - 250 Deg F	Stainless steel	240 vac	8.33 amps	Included	2000 Watts	83000X
830002	5000 psi	60 - 250 Deg F	Stainless steel	440 vac	4.5 amps	Included	2000 Watts	83000X

FRP Heater Kits

Part Number	Description
207-12351	115 volt mounting hardware kit, 2 fittings & hose – for mounting heaters to Unison (FRP) pump systems
207-12352	220 volt mounting hardware kit, 2 fittings & hose – for mounting heaters to Unison (FRP) pump systems

Air & Fluid Valves

BALL VALVES (LOW PRESSURE)	4-2
BALL VALVES (HIGH PRESSURE)	4-2
BALL VALVES (AIR VENT)	4-3
VA SERIES VALVES (AIR & FLUID)	4-3
AIR ADJUSTMENT VALVES	4-4
PRESSURE SAFETY RELIEF VALVES	4-4

Air & Fluid Valves

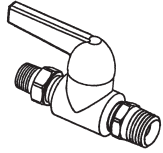

Ball Valves (Low Pressure)

Part No.	Thread Sizes	Max. Working Pressure	Materials	Useage	Service Form
72-83030	1/4"m x 1/4"m •	250 psi	Die cast (zinc plated)	Air / Fluid	77-2806
72-84040	3/8"m x 3/8"m •	250 psi	Die cast (zinc plated)	Air / Fluid	77-2806
72-81414	1/4"f x 1/4"f	250 psi	Die cast (zinc plated)	Air / Fluid	77-2806
72-84030	3/8"m x 1/4"m •	250 psi	Die cast (zinc plated)	Air / Fluid	77-2806
72-84015	3/8"m x 3/8"f •	250 psi	Die cast (zinc plated)	Air / Fluid	77-2806
73-81414	1/4"f x 1/4"f +	250 psi	Plated brass	3 Way	77-2806
73-83030	1/4"m x 1/4"m • +	250 psi	Plated brass	3 Way	77-2806
73-84040	3/8"m x 3/8"m • +	250 psi	Plated brass	3 Way	77-2806
849311	1/2"npt(f)	175 psi	Cast aluminum	Air	n/a

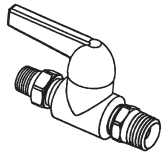

Ball Valves (High Pressure)

Part No.	Thread Sizes	Max. Working Pressure	Materials	Useage	Service Form
72-13030	1/4"m x 1/4"m •	4000 psi	Brass/steel	Fluid	77-2806
72-14040	3/8"m x 3/8"m •	4000 psi	Brass/steel	Fluid	77-2806
72-14030	3/8"m x 1/4"m •	4000 psi	Brass/steel	Fluid	77-2806
172-33535	1/4"m x 1/4"m •	4000 psi	Stainless steel	Fluid	77-2806
172-34545	3/8"m x 3/8"m •	4000 psi	Stainless steel	Fluid	77-2806
172-31414	1/4"f x 1/4"f	4000 psi	Stainless steel	Fluid	77-2806

• m = male thread (universal thread for use with "npt or" nps connections.)
 + = 1/4" npt(f) inlet fittings
 f = female thread (npt)
 fbe = female both ends

Air & Fluid Valves



237-269, 73-91100, 73-91300
Vented Ball Valve (Air)

Ball Valves (Air Vent)

Part No.	Thread Sizes	Max. Working Pressure	Materials	Useage	Service Form
237-269	1/2" fbe	250 psi	Brass	Air	n/a
73-91100	3/8" npt(f) x 3/8" npt(f)	250 psi	Brass	Air / Vent	n/a
73-91300	3/4" npt(f) x 3/4" npt(f)	250 psi	Brass	Air / Vent	n/a



VA Series
Ball Valves

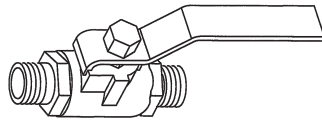

VA-595
Vented Ball Valve (Air)

VA Series Valves (Air & Fluid)

Part No.	Thread Sizes	Max. Working Pressure	Materials	Useage	Service Form
VA-527	3/8" npt(m) x 3/8" nps(m)	500 psi	Stainless steel	Air / Fluid	SB-11-119
VA-528	3/8" m x 3/8" f	500 psi	Stainless steel	Air / Fluid	SB-11-119
VA-540	3/8" m x 3/8" m	500 psi	Brass	Air / Fluid	SB-11-119
VA-542	1/4" m x 1/4" m	500 psi	Brass	Air / Fluid	SB-11-119
VA-595	1/2" npt(mbe)	175 psi	Brass	Air / Vented	SB-11-119

f = female Thread (npt)
fbe = female both ends
mbe = male both ends

Air & Fluid Valves

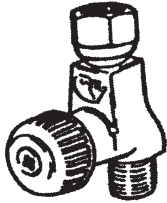

HAV-500
Air Valve

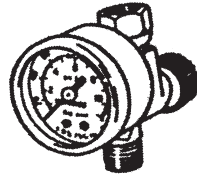

HAV-501
Air Valve



P-H-5516
In Line Air Valve

Air Adjusting Valves/Needle Valves/Cheater Valves

Part Number	Type	Inlet Size	Outlet Size	W or W/O Gauge Assy.	Max. Working Pressure	Recommended Range	Service Form
873409	Straight	1/4" npt(fbe)	1/4" npt(fbe)	W/O	100 psi	0-100 psi	n/a (not shown)
HAV-500	Straight	1/4" nps(m)	1/4" nps(f)	W/O	125 psi	0-125 psi	SB-11-119
HAV-501	Straight	1/4" nps(m)	1/4" nps(f)	W / gauge	125 psi	0-125 psi	SB-11-119
73-159	90 Degree	1/4" nps(m)	1/4" nps(f)	W/O	250 psi	0-125 psi	n/a (not shown)
P-H-5516	45 Degree	1/4" nps(m)	1/4" nps(f)	W/O	250 psi	0-125 psi	SB-11-119

fbe = Female Both Ends



Safety Valves

Pressure Safety Relief Valves

Part No.	Pressure Rating	npt Male Thread	Service Form	Notes
TIA-4326	18 psi	1/8"	SB-11-661	
TIA-4355	55 psi	1/4"	SB-11-661	
TIA-5080	80 psi	1/4"	SB-11-661	Replacement for TIA-4380
TIA-5110	110 psi	1/4"	SB-11-661	
85-243	55 psi	1/8"	n/a	

Hose, Connections & Assemblies

REUSABLE CONNECTIONS	5-2
UNDERSTANDING PRESSURE DROP	5-3
TECHNICAL DATA	5-4
BULK AIR HOSE & CONNECTIONS	5-5
BULK FLUID HOSE & CONNECTIONS	5-8
TUBING & CONNECTIONS	5-9
AIR HOSE ASSEMBLIES	5-12
FLUID HOSE ASSEMBLIES	5-14
FRP HOSE ASSEMBLIES	5-19
CATALYST HOSE ASSEMBLIES (FRP)	5-21

Hose, Connections & Assemblies

Reusable Connections

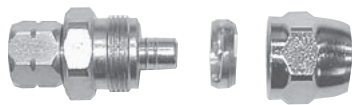

Type A. Plated Brass

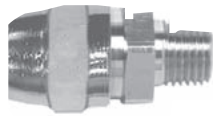

Type B. Plated Brass

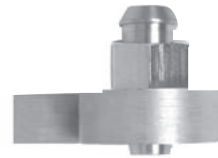

Type C. Plated Brass

How to Install Compression Sleeve Type Connections

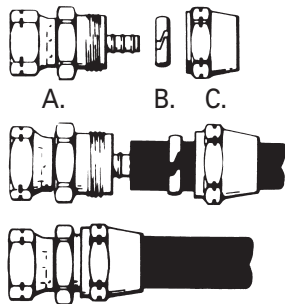

Place a matching double male nipple in a vise and tighten. Screw swivel nut onto fitting and tighten. Remove nut and sleeve from connector. Cut hose end square and slide nut over hose approximately 2 inches back from cut. Spread sleeve ring just enough to slide over hose easily. Push hose onto connector body, twisting hose slightly as you push to insure proper seating. Slide sleeve forward and tighten nut until connector body begins to turn. Remove double male nipple—hose and connection are ready to use. Tools required: vise, double male nipple, adjustable wrench, knife.

This connection consists of three (3) pieces:

- A. Swivel nut and connector body
- B. Sleeve
- C. Nut

How to Install Punch-Lok Type Connections

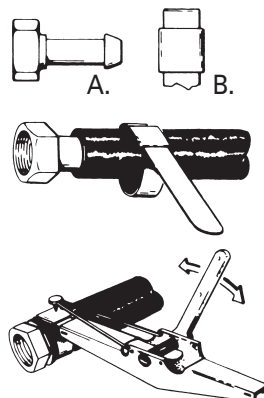

Place a matching double male nipple in a vise and tighten. Screw swivel nut onto fitting and tighten. Cut hose end square and slide Punch-Lok strap onto hose about 3 inches from cut end. Push hose onto connection tailpiece and slide strap forward to approximately 1/4 inch from connector body nut. Insert end of strap into Punch-Lok tool and tighten. Do not overtighten or strap will cut hose. Hold tension on strap and position punch. Strike punch with hammer to lock strap in place. The Punch-Lok tool, when moved up and down will sever excess strap. Remove double male nipple, and hose connection is complete. Tools required: Vise, Punch-Lok tool, double male nipple, adjustable wrench, knife, hammer.

This connection consists of two (2) pieces:

- A. Swivel nut with tailpiece
- B. Punch-Lok strap

E.V.A. = Ethylene Vinyl Acetate E.P.D.M. = Ethylene Propylene Diene Rubber s.s. = stainless steel
Steel pltd = Steel plated Brass pltd = Brass plated

Hose, Connections & Assemblies

Understanding Pressure Drop

Pressure Drop Basics

Understanding pressure drop requires a basic knowledge of cfm (cubic feet per minute) and psi (pounds per square inch). cfm refers to the given volume of air that flows past a given point in one minute. psi is the amount of force pushing the cubic foot of air through the hose or tool.

The amount of air that a tool consumes will remain constant for a given set of conditions. Pressure will always drop when the tool is turned on and when the air begins to flow through the hose. In addition, pressure drop will vary in relation to any adjustment made on the tool.

The same pressure loss principles apply when moving fluid through a hose. Be sure to consider pressure loss when choosing fluid hose and fittings.

Pressure Drop Points

Losses in pressure (psi) are dependent on the variables of hose length, hose diameter, volume (cfm), and the number and design of quick disconnects. To minimize the effects of pressure drop and the resulting lack of volume, consider the following:

- Frictional resistance between the fluid and the walls of the hose
- Internal resistance (shear)—fluid moves faster through the center of the hose and slower against the walls
- Change in direction of air or fluid through the system
- Volume at any given time as determined by back pressure
- The number of system connections, adapters, nipples, valves, filters, and air and fluid controls
- Hose i.d.—use the minimum i.d. necessary for each application
- Hose length—pressure drop is proportional to hose length
- Surface of the hose's inner tube—a rough surface can increase pressure drop up to 50%

Pressure Drop Chart Hose Sizes: 1/4" to 1" I.D.

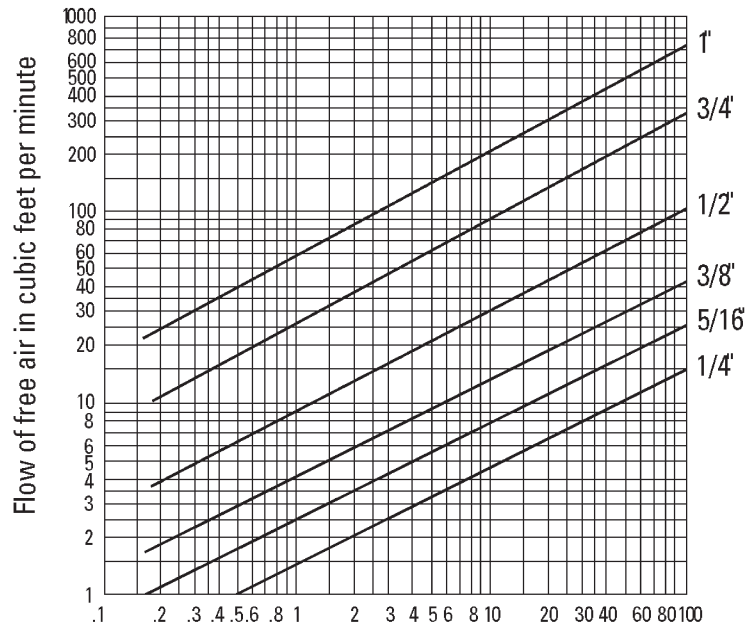

Pressure drop in pounds per sq. in., per 100 ft. of hose

To determine pressure drops for hose lengths other than 100 ft.:

$$(\text{Pressure Drop Chart Figure}) \times \frac{(\text{Ft. of Hose})}{100} = \text{Pressure drop for hose used}$$

Technical Data

This chart is for approximating and should only serve as a guide in sizing air hose. Pressure drop is directly proportional to hose lengths. That means that if hose length doubles, for example, pressure drop doubles.

Example:

- 100 ft. x 1/2 in. i.d. hose at 40 cfm has a pressure loss of 17.5 psi.
- 200 ft. x 1/2 in. i.d. will lose 35 psi.
- 50 ft. x 1/2 in. i.d. will lose between 8 to 9 psi.

E.V.A. = Ethylene Vinyl Acetate

E.P.D.M. = Ethylene Propylene Diene Rubber

s.s. = stainless steel

Steel pltd = Steel plated

Brass pltd = Brass plated

Hose, Connections & Assemblies

Technical Data

Chemical Resistance Chart

TYPES OF SOLVENTS, THINNERS, CATALYSTS	FLUIDALL™ FLUID HOSE	HIGH PRESSURE AIRLESS	Nylon TUBING	POLYETHYLENE TUBING
Drying Oils, Alkyds (Mineral Spirits)(Naphtha)	●■	●■	●■	●
Phenolic Varnishes, Epoxy Esters Coal Tars, 1 Pkg. Urethanes (Naphtha – Toluene Blend)	●■	●■	●■	●
Chlorinated Rubber, Chlor. Rub. Zinc Rich Silicones, "Hypalon" (Toluene), (Xylene)	●■	●■	●■	○
Phenolics, Epoxies, Epoxy Zinc Rich Vinyl Alkyds (Toluene – MEK Blend)	●■	●■	●■	○
Vinyls, Vinyl-Acrylics, Polyesters, Polyester Zinc Rich, (MEK), (MIBK)	●■	●■	●■	○
Lacquers, 2 Pkg. Urethanes High Gloss Enamels (Ketone – Ester Blend)	●■	●■	●■	○
PV Acetate, Polyacrylics Latex, Zinc Silicates, (Water Based)	●	●	●	●
Water-Based	●	●	●	-
Aromatic, Solvent Based	-	●	-	-
Chlorinated, Solvent Based	●	●	●	-

KEY TO CHART:

Material at Room Temperature: ● Continuous Service ○ Intermittent Service

Heated Material: ■ Continuous Service

Common Terms

(f)	Female Thread	sw	Swivel
(fbe)	Female Both Ends	wp	Maximum Working Pressure
(m)	Male Thread	mpa	? x 145 = P.S.I.
(mbe)	Male Both Ends		
cfm	Cubic Feet Per Minute		
i.d.	Inside Diameter		
J.I.C.	Joint Industrial Council		
nps	National Pipe Straight		
npt	National Pipe Tapered		
o.d.	Outside Diameter		
psi	Pounds Per Square Inch		
s.s.	Stainless Steel		

Metric Conversion

1 cm.	= 0.3937 in.
1 bar	= 14.5 psi.
1 liter	= 0.264 gal. (U.S.)
1 kg.	= 2.205 lb.
1 meter	= 3.28 ft.
1 millimeter	= 0.03937 inches

E.V.A. = Ethylene Vinyl Acetate E.P.D.M. = Ethylene Propylene Diene Rubber s.s. = stainless steel
Steel pltd = Steel plated Brass pltd = Brass plated

Hose, Connections & Assemblies

Premium Spray Finishing Air Hose (Smooth Cover)

Recommended Use

Premium spray finishing air hose. Class B oil resistance. Designed for all finishing operations as well as rugged industrial applications, especially applications requiring lubricants in the airline supply or where oil and grease are present in the environment. Excellent for use with water and water-based materials. Temperature range from -40°F to +200° F (max).

Tube

EPDM Class B oil resistance.

Reinforcement

High tensile strength spiral reinforcement. Specially designed for maximum flexibility (under pressure) and maximum coupling retention.

Cover

EPDM, red, smooth. Abrasion resistant. Oil Resistance.

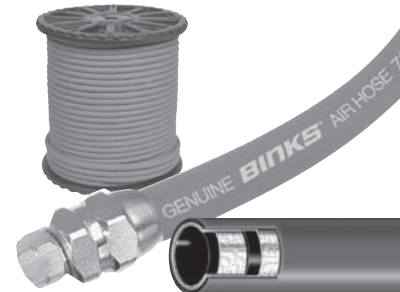

Bulk Hose Chart – Smooth Cover

SIZES AVAILABLE		BULK HOSE NUMBER	MAXIMUM WORKING PRESSURE (psi)	BEND RADIUS	STD. REEL	APPROX. SHIPPING WEIGHT	
I.D.	o.d.				LENGTH IN FT.	1 PIECE REELS	BASED ON FEET PER REEL
1/4"	1/2"	71-10000	250	2 3/4"	500	50 lbs.	10 lbs.
5/16"	5/8"	71-11000	250	3"	500	87 lbs.	16.2 lbs.
3/8"	11/16"	71-12000	250	3 1/2"	500	96 lbs.	18 lbs.
1/2"	7/8"	71-13000	250	5"	300	86 lbs.	26.8 lbs.
3/4"	1 1/8"	71-14000	250	6"	300	112 lbs.	35 lbs.

Air Hose Grounded with Static Wire

Recommended Use

Premium finishing air hose. Oil resistance, rating Class B. Designed for all finishing operations as well as rugged industrial applications. Static wire between tube and cover prevents build-up of static electricity. Commonly used with atomizing spray guns, electrostatic spray guns and equipment that requires grounding for safety purposes. Temperature range from -40° F to +200° F.

Tube

EPDM. Class B – Oil Resistance.

Reinforcement

High tensile strength synthetic spiral reinforcement. Specially designed for maximum flexibility (under pressure) and maximum coupling retention.

Cover

EPDM red, smooth, abrasion resistance. – Oil Resistant

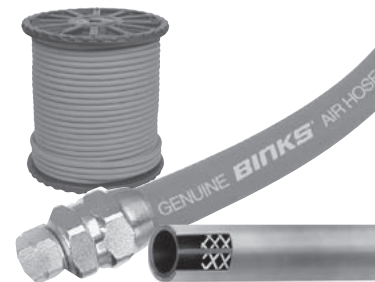

Bulk Hose Chart – Smooth Cover

SIZES AVAILABLE		BULK HOSE NUMBER	MAXIMUM WORKING PRESSURE (psi)	BEND RADIUS	STD. REEL	APPROX. SHIPPING WEIGHT	
I.D.	o.d.				LENGTH IN FT.	1 PIECE REELS	BASED ON FEET PER REEL
5/16"	.618"	71-20000	250	3"	500	87 lbs.	17.4 lbs.
3/8"	.701"	71-21000	250	3.5"	500	96 lbs.	19.2 lbs.

Recommended hose connection 72-1317-1/4" nps(f), 72-1325-1/4" nps(f)

E.V.A. = Ethylene Vinyl Acetate E.P.D.M. = Ethylene Propylene Diene Rubber s.s. = stainless steel
 Steel pltd = Steel plated Brass pltd = Brass plated

Hose, Connections & Assemblies

Connections for Premium & Static Wire Air Hose

Hose Size		For Bulk Hose No.	Connections		Type
i.d.	o.d.		Thread	Part No.	
1/4"	1/2"	71-10000	1/4" nps(f)	72-1303	A
			3/8" nps(f)	72-1306	A
			3/8" nps(f)s.s.	72-2143*	A
5/16"	5/8"	71-11000 71-20000	1/4" nps(f)	72-1317	A
			1/4" npt(m)	72-1478	B
			3/8" nps(f)	72-1320	A
3/8"	11/16"	71-12000	1/4" nps(f)	72-1325	A
			3/8" nps(f)	72-1328	A
			3/8" nps(f)s.s.	72-2146*	A
1/2"	7/8"	71-13000	3/8" nps(f)	72-1333	A
			1/2" nps(f)	72-1334	A
			1/2" nps(f)	72-954†*	C
3/4"	1 3/16"	71-14000	3/4" nps(f)	72-1336†	C
			3/4" nps(f)	72-417†	C
			3/4" nps(f)	72-955†*	C
Ergoflex™ Air Hose Connections					
3/8"	.646"	71-31000	1/4" nps(f)	72-2008	A

†Punch-Lok Connection *Stainless Steel tailpiece

For Connection Sleeves, see Tech Sheet #77-5374.



Type A. Plated Brass

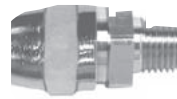

Type B. Plated Brass

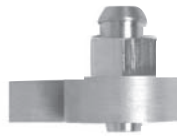

Type C. Plated Brass

Hose, Connections & Assemblies

Lightweight ErgoFlex™ Air Hose (Smooth Cover)

Recommended Use

Binks ErgoFlex™ HLVP Hose is suitable for use with all kinds of air-operated equipment, including those requiring lubricant in the air line, or in environments where oil and grease are present.

Tube

Black EPDM Class B – Oil Resistance.

Reinforcement

Synthetic yarn –
Spiral reinforcement.

Cover

Tan EPDM, smooth,
Class C – Oil resistance.



Bulk Hose Chart – Smooth Cover

SIZES AVAILABLE		BULK HOSE NUMBER	MAXIMUM WORKING PRESSURE (psi)	BEND RADIUS	STD. REEL	APPROX.	HOSE WEIGHT PER 100 FEET
I.D.	o.d.				LENGTH IN FT. 1 PIECE REELS	SHIPPING WEIGHT BASED ON FEET PER REEL	
3/8"	.646"	71-31000	125	3 1/2"	500	70 lbs.	12.8 lbs.

Connections for Ergoflex™ Air Hose

Hose Size		For Bulk Hose No.	Connections		Type
i.d.	o.d.		Thread	Part No.	
3/8"	.646"	71-31000	1/4" nps(f)	72-2008	A



Type A. Plated Brass

E.V.A. = Ethylene Vinyl Acetate E.P.D.M. = Ethylene Propylene Diene Rubber s.s. = stainless steel
Steel pltd = Steel plated Brass pltd = Brass plated

Hose, Connections & Assemblies

Fluidall™ Fluid Hose (Nylon Lined, Maximum Versatility)

Recommended Use

Premium, versatile fluid hose, for finishing operations plus a wide range of fluid applications. Fluidall™ is ideal for resins and solvents contained in latices, epoxies, urethanes, alkyds, primers, acrylics, polyesters, silicones, bitumastic coatings, oil and water based paints, lacquers, alcohol and latex coatings. Temperature range from 0° F to +190°F (max).



Tube

Nylon.

Reinforcement

High tensile synthetic braid. Specially designed for maximum flexibility (under pressure) and maximum coupling retention.

Cover

Black, synthetic, smooth rubber. Class B – Oil Resistance.

Bulk Hose Chart – Smooth Cover

SIZES AVAILABLE		BULK HOSE NUMBER	MAXIMUM WORKING PRESSURE (psi)	BEND RADIUS	STD. REEL	APPROX.	HOSE WEIGHT PER 100 FEET
I.D.	o.d.				LENGTH IN FT. 1 PIECE REELS	SHIPPING WEIGHT BASED ON FEET PER REEL	
1/4"	1/2"	71-280	500	3"	500	43 lbs.	8 lbs.
3/8"	11/16"	71-282	500	3 1/2"	500	83 lbs.	15 lbs.
1/2"	7/8"	71-283	750	5"	300	74 lbs.	22 lbs.
3/4"	1 3/16"	71-284	750	8"	300	118 lbs.	36 lbs.
1"	1 1/2"	71-285	750	12"	300	168 lbs.	53 lbs.

Connections for Fluidall™ Fluid Hose

Hose Size		For Bulk Hose No.	Connections		Type
i.d.	o.d.		Thread	Part No.	
1/4"	1/2"	71-280	1/4" nps(f)	72-1303	A
			3/8" nps(f)	72-1306	A
			3/8" nps(f)s.s.	72-2143*	A
3/8"	11/16"	71-282	1/4" nps(f)	72-1325	A
			3/8" nps(f)	72-1328	A
			3/8" nps(f)s.s.	72-2146*	A
1/2"	7/8"	72-283	3/8" nps(f)	72-1333	A
			1/2" nps(f)	72-1334	A
			1/2" nps(f)	72-954†*	C
3/4"	1 3/16"	71-284	3/4" nps(f)	72-1336†	C
			3/4" nps(f)	72-417†	C
			3/4" nps(f)	72-955†*	C
1"	1 1/2"	71-285	1" nps(f)	72-418†	C
			1" nps(f)	72-956*	C

†Punch-Lok Connection *Stainless Steel tailpiece



Type A. Plated Brass



Type B. Plated Brass

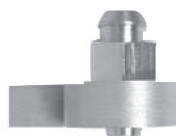

Type C. Plated Brass

E.V.A. = Ethylene Vinyl Acetate E.P.D.M. = Ethylene Propylene Diene Rubber s.s. = stainless steel
 Steel pltd = Steel plated Brass pltd = Brass plated

Hose, Connections & Assemblies

Tubing & Connections

Nylon Tubing & Connections

Size	Tubing No.	Max. Working Pressure (psi)		Connection Part No.	Connection Description
		@ 70 DEG. F.	@ 150 DEG. F.		
1/16" i.d. x .1/8" o.d.	H-3671			SSP-6120	Nylon 1/8" npt(f) swivel
1/8" i.d. x .225" o.d.	71-226	475 250	190	PLH-1838-SS	s.s. 3/8" nps(f) swivel
				72-1677	Brass 1/4" nps(f) swivel
3/16" i.d. x 1/4" o.d.	71-230	225 200	190	PLH-31638-SS	s.s. 3/8" nps(f) swivel
				72-1729	Brass 3/8" nps(f) swivel
				72-1793	s.s. 3/8" nps(f) swivel w/ spring guard
				72-1679	Brass 1/4" nps(f) swivel
				72-1747	Brass 1/4" nps(f) swivel w. Spring guard
				72-1789	s.s. 1/4" nps(f) swivel
				72-1792	s.s. 1/4" nps(f) swivel w. Spring guard
1/4" i.d. x .350" o.d.	71-227	225 250	190	72-1680	Brass 1/8" npt(m)
				72-1681	Brass 1/4" nps(f) swivel
				72-1683	Brass 3/8" nps(f) swivel
				72-1687	Brass 1/4" nps(f) swivel w/ spring guard
				72-1689	Brass 3/8" nps(f) swivel w/ spring guard
				72-1799	s.s. 1/4" nps(f) swivel
				72-1800	s.s. 1/4" nps(f) swivel w/ spring guard
				72-1801	s.s. 3/8" nps(f) swivel
				72-1802	s.s. 3/8" nps(f) swivel w/ spring guard
3/8" i.d. x 1/2" o.d.	71-229	200	140	72-1685	Brass 3/8" nps(f) swivel
				72-1811	s.s. 1/4" nps(f) swivel
				72-1812	s.s. 3/8" nps(f) swivel

5

E.V.A. = Ethylene Vinyl Acetate E.P.D.M. = Ethylene Propylene Diene Rubber s.s. = stainless steel
 Steel pltd = Steel plated Brass pltd = Brass plated

Hose, Connections & Assemblies

Tubing & Connections

Polyethylene Tubing & Connections

Size	Tubing No.	Max. Working Pressure (psi)	Connection Part No.	Connection Description
.175" i.d. x 1/4" o.d.	H-2339	125	P-HC-4728	Brass-alum-steel 1/4" nps(f) swivel
			P-HC-4221	Brass-alum-steel 1/4" nps(f) swivel w/ spring guard
1/4" i.d. x 3/8" o.d.	H-2338	125	72-1579	Brass 1/4" nps(f) swivel
			72-1581	Brass 3/8" nps(f) swivel
			72-1583	Brass 1/4" nps(f) swivel w/ spring guard
			72-1585	Brass 3/8" nps(f) swivel w/ spring guard
			72-1839	s.s. 3/8" nps(f) swivel
			72-1968	s.s. 1/4" nps(f) swivel
			72-1983	s.s. 1/4" nps(f) swivel w/ spring guard
			72-2060	s.s. 3/8" nps(f) swivel w/ spring guard

5

E.V.A. Tubing & Connections

Size	Tubing No.	Max. Working Pressure (psi)	Connection Part No.	Connection Description
1/8" i.d. x 5/16" o.d.	71-201	100	102-3031	316 s.s. 1/4" (f)
5/16" i.d. X 17/32" o.d.	71-508	250	72-1646	416 s.s. 1/4" nps(f)
3/8" i.d. x 19/32" o.d.	71-509	250	102-3040	316 s.s. 3/8" nps(f)

E.V.A. = Ethylene Vinyl Acetate E.P.D.M. = Ethylene Propylene Diene Rubber s.s. = stainless steel
 Steel pltd = Steel plated Brass pltd = Brass plated

Hose, Connections & Assemblies

Tubing & Connections

Teflon Tubing & Connections

Size	Tubing No.	Max. Working Pressure (psi)	Connection Part No.	Connection Description
1/4" i.d. x 3/8" o.d.	71-204	140	72-1579	Brass 1/4" nps(f) swivel
			72-1581	Brass 3/8" nps(f) swivel
			72-1583	Brass 1/4" nps(f) swivel w/ spring guard
			72-1585	Brass 3/8" nps(f) swivel w/ spring guard
			72-1839	s.s. 3/8" nps(f) swivel
			72-1968	s.s. 1/4" nps(f) swivel
			72-1983	s.s. 1/4" nps(f) swivel w/ spring guard
			72-2060	s.s. 3/8" nps(f) swivel w/ spring guard
			54-4976	Push-lok 1/4" nps(f)*
54-4975	Push-lok 1/8" npt(m)*			
*plastic & plated steel				
1/8" i.d. x 1/4" o.d.	71-248	140	72-1944	Brass 1/4" nps(f) swivel
			72-1945	s.s. 3/8" nps(f) swivel
3/16" i.d. x 5/16" o.d.	71-209	140	72-1577	Brass 1/4" nps(f) swivel
			72-1730	Brass 3/8" nps(f) swivel
3/8" i.d. x 1/2" o.d.	71-207	140	72-1685	Brass 3/8" nps(f) swivel
			72-1811	s.s. 1/4" nps(f) swivel
			72-1812	s.s. 3/8" nps(f) swivel

Polyurethane Tubing & Connections

Size	Tubing No.	Max. Working Pressure (psi)	Connection Part No.	Connection Description
1/4" i.d. x 3/8" o.d.	54-4987	100	54-4976	Push-lok 1/4" nps(f)*
			54-4975	Push-lok 1/8" npt(m)*
			72-1579	Brass 1/4" nps(f) swivel
			72-1583	Brass 1/4" nps(f) swivel w/ spring guard

*plastic & plated steel

E.V.A. = Ethylene Vinyl Acetate E.P.D.M. = Ethylene Propylene Diene Rubber s.s. = stainless steel
 Steel pltd = Steel plated Brass pltd = Brass plated

Hose, Connections & Assemblies

Air Hose Assemblies

Premium Air Hose Assemblies (Low Pressure)

Part Number	Bulk Hose No.	Size	Max. Working Pressure	Tube Material	Connection Part No.	Threads	Connection Material
71-1101	71-10000	1/4" i.d. x 1/2" o.d. x 5 ft.	250 psi	E.P.D.M.	72-1303	1/4" nps(f)	Brass pltd
71-1105	71-10000	1/4" i.d. x 1/2" o.d. x 25 ft.	250 psi	E.P.D.M.	72-1303	1/4" nps(f)	Brass pltd
71-1106	71-10000	1/4" i.d. x 1/2" o.d. x 50 ft.	250 psi	E.P.D.M.	72-1303	1/4" nps(f)	Brass pltd
71-1201	71-11000	5/16" i.d. x 5/8" o.d. x 5 ft.	250 psi	E.P.D.M.	72-1317	1/4" nps(f)	Brass pltd
71-1203	71-11000	5/16" i.d. x 5/8" o.d. x 15 ft.	250 psi	E.P.D.M.	72-1317	1/4" nps(f)	Brass pltd
71-1205	71-11000	5/16" i.d. x 5/8" o.d. x 25 ft.	250 psi	E.P.D.M.	72-1317	1/4" nps(f)	Brass pltd
71-1206	71-11000	5/16" i.d. x 5/8" o.d. x 50 ft.	250 psi	E.P.D.M.	72-1317	1/4" nps(f)	Brass pltd
71-1209	71-11000	5/16" i.d. x 5/8" o.d. x 6 ft.	250 psi	E.P.D.M.	72-1317	1/4" nps(f)	Brass pltd
71-1355	71-12000	3/8" i.d. x 11/16" o.d. x 25 ft.	250 psi	E.P.D.M.	72-1325	1/4" nps(f)	Brass pltd
71-1356	71-12000	3/8" i.d. x 11/16" o.d. x 50 ft.	250 psi	E.P.D.M.	72-1325	1/4" nps(f)	Brass pltd

Air Hose Assemblies (Grounded with Static Wire)

Part Number	Bulk Hose No.	Size	Max. Working Pressure	Tube Material	Connection Part No.	Threads	Connection Material
71-2803	71-20000	5/16" i.d. x 5/8" o.d. x 25 ft.	250 psi	E.P.D.M.	72-1317	1/4" nps(f)	Brass pltd
71-2810	71-20000	5/16" i.d. x 5/8" o.d. x 35 ft.	250 psi	E.P.D.M.	72-1317	1/4" nps(f)	Brass pltd
71-2804	71-20000	5/16" i.d. x 5/8" o.d. x 50 ft.	250 psi	E.P.D.M.	72-1317	1/4" nps(f)	Brass pltd

E.V.A. = Ethylene Vinyl Acetate E.P.D.M. = Ethylene Propylene Diene Rubber s.s. = stainless steel
 Steel pltd = Steel plated Brass pltd = Brass plated

Hose, Connections & Assemblies

Air Hose Assemblies

Ergoflex Air Hose Assemblies

Part Number	Bulk Hose No.	Size	Max. Working Pressure	Tube Material	Connection Part No.	Threads	Connection Material
71-31101	H-3670	.390 i.d. x .650 o.d. x 25 ft.	200 psi	E.P.D.M.	72-2008	1/4" nps(f)	Brass pltd
71-31102	H-3670	.390 i.d. x .650 o.d. x 50 ft.	200 psi	E.P.D.M.	72-2008	1/4" nps(f)	Brass pltd
71-31103	H-3670	.390 i.d. x .650 o.d. x 6 ft.	200 psi	E.P.D.M.	72-2008	1/4" nps(f)	Brass pltd

1/4" I.D. Air Hose Assemblies (Low Pressure – Air Assist Supply)

Part Number	Bulk Hose No.	Size	Max. Working Pressure	Tube Material	Connection Part No.	Threads	Connection Material
71-4990	54-4987	1/4" i.d. x 3/8" o.d. x 15 ft.	250 psi	Polyurethane	54-4976 Tubing connector	n/a	n/a
71-4991	54-4987	1/4" i.d. x 3/8" o.d. x 25 ft.	250 psi	Polyurethane	54-4976 Tubing connector	1/4" npt(m)	n/a

1/8" I.D. Air Hose Assemblies (for Wren Airbrush)

Part Number	Bulk Hose No.	Size	Max. Working Pressure	Tube Material	Connection Part No.	Threads	Connection Material
59-98	71-113	1/8" i.d. x 5/16" o.d. x 12 ft.	250 psi	Rubber	72-93 x 59-50	1/4" nps(f) x 1/4"-40(f)	Brass pltd

Breathable Air Hose Assemblies (For MPV Air Respirator)

Part Number	Bulk Hose No.	Size	Max. Working Pressure	Tube Material	Connection Part No.	Threads	Connection Material
MPV-457	n/a	(see note)	n/a	n/a	n/a	n/a	n/a
MPV-530	n/a	5/16" i.d. (see note)	250 psi	Rubber	n/a	male stem / QD	Steel pltd
MPV-550	n/a	5/16" i.d. (see note)	250 psi	Rubber	n/a	male stem / QD	Steel pltd

Note: These MPV hose assemblies are used with the MPV-625 Air Supplied Respirator only, and are NIOSH approved. Alternate hoses must not be substituted. Otherwise, NIOSH approval will be void, and an unsafe condition may result.

E.V.A. = Ethylene Vinyl Acetate E.P.D.M. = Ethylene Propylene Diene Rubber s.s. = stainless steel
Steel pltd = Steel plated Brass pltd = Brass plated

Hose, Connections & Assemblies

Fluid Hose Assemblies

Fluidall™ Hose Assemblies (Low Pressure)

Part Number	Bulk Hose No.	Size	Max. Working Pressure	Tube Material	Connection Part No.	Threads	Connection Material
71-3260	71-280	1/4" i.d. x 1/2" o.d. x 5 ft.	500 psi	Nylon	72-1303	1/4" nps(f)	Brass pltd
71-3263	71-280	1/4" i.d. x 1/2" o.d. x 25 ft.	500 psi	Nylon	72-1303	1/4" nps(f)	Brass pltd
71-3279	71-280	1/4" i.d. x 1/2" o.d. x 9"	500 psi	Nylon	72-1303	1/4" nps(f)	Brass pltd
71-3380	71-280	1/4" i.d. x 1/2" o.d. x 5 ft.	500 psi	Nylon	72-1306	3/8" nps(f)	Brass pltd
71-3383	71-280	1/4" i.d. x 1/2" o.d. x 25 ft.	500 psi	Nylon	72-1306	3/8" nps(f)	Brass pltd
71-3384	71-280	1/4" i.d. x 1/2" o.d. x 50 ft.	500 psi	Nylon	72-1306	3/8" nps(f)	Brass pltd
71-3390	71-280	1/4" i.d. x 1/2" o.d. x 35 ft.	500 psi	Nylon	72-1306	3/8" nps(f)	Brass pltd
71-3663	71-280	1/4" i.d. x 1/2" o.d. x 25 ft.	500 psi	Nylon	72-2143	3/8" nps(f)	s.s.
71-3300	71-282	3/8" i.d. x 11/16" o.d. x 5 ft.	500 psi	Nylon	72-1328	3/4" nps(f)	Brass pltd
71-3303	71-282	3/8" i.d. x 11/16" o.d. x 25 ft.	500 psi	Nylon	72-1328	3/4" nps(f)	Brass pltd
71-3304	71-282	3/8" i.d. x 11/16" o.d. x 50 ft.	500 psi	Nylon	72-1328	3/4" nps(f)	Brass pltd
71-3313	71-282	3/8" i.d. x 11/16" o.d. x 17"	500 psi	Nylon	72-1328	3/4" nps(f)	Brass pltd
71-3400	71-283	1/2" i.d. x 7/8" o.d. x 5 ft.	750 psi	Nylon	72-1334	1/2" nps(f)	Brass pltd
71-3403	71-283	1/2" i.d. x 7/8" o.d. x 25 ft.	750 psi	Nylon	72-1334	1/2" nps(f)	Brass pltd
71-3404	71-283	1/2" i.d. x 7/8" o.d. x 50 ft.	750 psi	Nylon	72-1334	1/2" nps(f)	Brass pltd
71-3360	71-285	1" i.d. x 1 1/2" o.d. x 5 ft.	750 psi	Nylon	72-1936	1" nps(f)	Brass pltd
71-3361	71-285	1" i.d. x 1 1/2" o.d. x 10 ft.	750 psi	Nylon	72-1936	1" nps(f)	Brass pltd
71-3367	71-285	1" i.d. x 1 1/2" o.d. x 8 ft.	750 psi	Nylon	72-1936	1" nps(f)	Brass pltd

E.V.A. = Ethylene Vinyl Acetate E.P.D.M. = Ethylene Propylene Diene Rubber s.s. = stainless steel
 Steel pltd = Steel plated Brass pltd = Brass plated

Hose, Connections & Assemblies

Fluid Hose Assemblies

Hose Assembly Sets (Air & Fluid)

Part Number	Bulk Hose No.	Size	Max. Working Pressure	Tube Material	Connection Part No.	Threads	Connection Material
6-438	71-131	5/16" i.d. x 5/8" o.d. x 25 ft. 3/8" i.d. x 11/16" o.d. x 25 ft.	250 psi	Rubber	72-1317	1/4" nps(f) air	Brass pltd
	71-282	3/8" i.d. x 11/16" o.d. x 25 ft.	500 psi	Nylon	72-1328	3/8" nps(f) fluid	Brass pltd
KB-4006	71-131	5/16" i.d. x 5/8" o.d. x 6 ft.	250 psi	Rubber	72-1317	1/4" nps(f) air	Brass pltd
	71-282	3/8" i.d. x 11/16" o.d. x 6 ft.	500 psi	Nylon	72-1328	3/8" nps(f) fluid	Brass pltd

Siphon Fluid Hose Assemblies

Part Number	Bulk Hose No.	Size	Max. Working Pressure	Tube Material	Connection Part No.	Threads	Connection Material
41-11211	71-284	3/4" i.d. x 1-3/16" o.d. x 5 ft.	750 psi	Nylon	(2) 72-1935	3/4" nps(f)	Steel pltd
41-11216	71-284	3/4" i.d. x 1-3/16" o.d. x 8 ft.	750 psi	Nylon	(2) 72-1935	3/4" nps(f)	Steel pltd
41-11210	71-285	1" i.d. x 1-1/2" o.d. x 8 ft.	750 psi	Nylon	(2) 72-1936	1" nps(f)	Steel pltd
41-11212	71-285	1" i.d. x 1-1/2" o.d. x 5 ft.	750 psi	Nylon	(2) 72-1936	1" nps(f)	Steel pltd
44-1641	71-285	1" i.d. x 1-1/2" o.d. x 7 ft.	750 psi	Nylon	(2) 72-2329, 72-2330, 72-415	(2) 1" nps(f)	s.s.
103-1313	71-285	1" i.d. x 1 1/2" o.d. x 8 ft.	750 psi	Nylon	72-1936	1" npt(f)	Steel pltd
103-1349	71-285	1" i.d. x 1 1/2" o.d. x 8 ft.	750 psi	Nylon	72-1936, 72-1937	1" npt(f) x 1" npt(f)	Steel pltd
103-1350	71-285	1" i.d. x 1 1/2" o.d. x 5 ft.	750 psi	Nylon	72-1936, 72-1937	1" npt(f) x 1" npt(f)	Steel pltd
103-2029	71-285	1" i.d. x 1 1/2" o.d. x 8 ft.	750 psi	Nylon	72-1937, 72-1981	1" nps(m) x 1" npt(m)	Steel pltd

E.V.A. = Ethylene Vinyl Acetate E.P.D.M. = Ethylene Propylene Diene Rubber s.s. = stainless steel
 Steel pltd = Steel plated Brass pltd = Brass plated

Hose, Connections & Assemblies

Fluid Hose Assemblies

Nylon Tube Assemblies

Part Number	Bulk Hose No.	Size	Max. Working Pressure	Tube Material	Connection Part No.	Threads	Connection Material
71-7687	71-230	3/16" i.d. x .264 o.d. x 25 ft.	225 psi	Nylon	72-1793, 72-1792	1/4" nps(f) x 3/8" nps(f)	303 s.s.
71-7686	71-230	3/16" i.d. x .264 o.d. x 15 ft.	225 psi	Nylon	72-1792, 72-1793	1/4" nps(f) x 3/8" nps(f)	w/ Spring guards
71-7797	71-229	3/8" i.d. x 1/2" o.d. x 15 ft.	200 psi	Nylon	72-1812	3/8" nps(f)	s.s.
71-7361	71-227	1/4" i.d. x 50 ft.	225 psi	Nylon	72-12681	1/4" nps Spring Guards	Brass pltd
71-7363	71-227	1/4" i.d. x 5 ft.	225 psi	Nylon	72-1687	1/4" nps Spring Guards	Brass pltd

Fluid Hose Drains (Low Pressure)(connection one end)

Part Number	Bulk Hose No.	Size	Max. Working Pressure	Tube Material	Connection Part No.	Threads	Connection Material
71-7328	71-227	1/4" i.d. x .350 o.d. x 23"	225 psi	Nylon	72-63, 72-93	1/4" nps(f)	Brass pltd
71-7332	71-227	1/4" i.d. x .350 o.d. x 3 ft.	225 psi	Nylon	72-63, 72-93	1/4" nps(f)	Brass pltd

Contractor Quality Airless Paint Hose (Conductive -No Wire)

Part Number	Bulk Hose No.	Size	Max. Working Pressure	Tube Material	Connection Part No.	Threads	Connection Material
71-3530	n/a	1/4" i.d. x 25 ft.	3300 psi	Nylon	n/a	1/4" nps(f)	Steel pltd
71-3531	n/a	1/4" i.d. x 50 ft.	3300 psi	Nylon	n/a	1/4" nps(f)	Steel pltd

E.V.A. = Ethylene Vinyl Acetate E.P.D.M. = Ethylene Propylene Diene Rubber s.s. = stainless steel
 Steel pltd = Steel plated Brass pltd = Brass plated

Hose, Connections & Assemblies

Fluid Hose Assemblies

Premium Airless Paint Hose (Conductive -No Wire)

Part Number	Bulk Hose No.	Size	Max. Working Pressure	Tube Material	Connection Part No.	Threads	Connection Material
71-8085	n/a	3/16" i.d. x 5 ft.	3000 psi	Nylon	Permanent	1/4" nps(f)	Steel pltd
71-8088	n/a	3/16" i.d. x 25 ft.	3000 psi	Nylon	Permanent	1/4" nps(f)	Steel pltd
71-8089	n/a	3/16" i.d. x 50 ft.	3000 psi	Nylon	Permanent	1/4" nps(f)	Steel pltd
71-7703	n/a	1/4" i.d. x 15 ft.	3000 psi	Nylon	Permanent	1/4" nps(f)	Steel pltd
71-7704	n/a	1/4" i.d. x 25 ft.	3000 psi	Nylon	Permanent	1/4" nps(f)	Steel pltd
71-7705	n/a	1/4" i.d. x 50 ft.	3000 psi	Nylon	Permanent	1/4" nps(f)	Steel pltd
71-7708	n/a	1/4" i.d. x 5 ft.	3000 psi	Nylon	Permanent	1/4" nps(f)	Steel pltd
71-7709	n/a	1/4" i.d. x 10 ft.	3000 psi	Nylon	Permanent	1/4" nps(f)	Steel pltd
71-7501	n/a	5/16" i.d. x 5 ft.	3000 psi	Nylon	Permanent	1/4" nps(f)	Steel pltd
71-7504	n/a	5/16" i.d. x 25 ft.	3000 psi	Nylon	Permanent	1/4" nps(f)	Steel pltd
71-7505	n/a	5/16" i.d. x 50 ft.	3000 psi	Nylon	Permanent	1/4" nps(f)	Steel pltd
71-7508	n/a	5/16" i.d. x 35 ft.	3000 psi	Nylon	Permanent	1/4" nps(f)	Steel pltd
71-8421	n/a	3/8" i.d. x 5 ft.	3000 psi	Nylon	Permanent	3/8" nps(f)	Steel pltd
71-8422	n/a	3/8" i.d. x 10 ft.	3000 psi	Nylon	Permanent	3/8" nps(f)	Steel pltd
71-8424	n/a	3/8" i.d. x 25 ft.	3000 psi	Nylon	Permanent	3/8" nps(f)	Steel pltd
71-8425	n/a	3/8" i.d. x 50 ft.	3000 psi	Nylon	Permanent	3/8" nps(f)	Steel pltd
71-8427	n/a	3/8" i.d. x 100 ft.	3000 psi	Nylon	Permanent	3/8" nps(f)	Steel pltd

E.V.A. = Ethylene Vinyl Acetate E.P.D.M. = Ethylene Propylene Diene Rubber s.s. = stainless steel
 Steel pltd = Steel plated Brass pltd = Brass plated

Hose, Connections & Assemblies

Fluid Hose Assemblies

PIT BULL™ Airless Paint Hose (Conductive)

Part Number	Bulk Hose No.	Size	Max. Working Pressure	Tube Material	Connection Type	Threads	Connection Material
71-4830	n/a	1/4" i.d. x 25 ft.	4000 psi	Nylon	w/ Spring Guards	1/4" nps(f)	Steel pltd
71-4831	n/a	1/4" i.d. x 50 ft.	4000 psi	Nylon	w/ Spring Guards	1/4" nps(f)	Steel pltd
71-4840	n/a	1/4" i.d. x 25 ft.	10,000 psi	Nylon	w/ Spring Guards	1/4" nps(f)	Steel pltd
71-4841	n/a	1/4" i.d. x 50 ft.	10,000 psi	Nylon	w/ Spring Guards	1/4" nps(f)	Steel pltd
71-4850	n/a	3/8" i.d. x 25 ft.	3500 psi	Nylon	Permanent	3/8" nps(f)	Steel pltd
71-4851	n/a	3/8" i.d. x 50 ft.	3500 psi	Nylon	Permanent	3/8" nps(f)	Steel pltd
71-4860	n/a	3/8" i.d. x 25 ft.	8000 psi	Nylon	Permanent	3/8" nps(f)	Steel pltd
71-4861	n/a	3/8" i.d. x 50 ft.	8000 psi	Nylon	Permanent	3/8" nps(f)	Steel pltd

PIT BULL™ Whip-End Fluid Hose Assemblies

Part Number	Bulk Hose No.	Size	Max. Working Pressure	Tube Material	Connection Type	Threads	Connection Material
71-4870	n/a	1/4" i.d. x 3 ft.	10,000 psi	Nylon	n/a	3/8" nps(m) x 1/4" nps(f)	Steel pltd
71-4871	n/a	1/4" i.d. x 3 ft.	10,000 psi	Nylon	n/a	1/4" nps(m) x 1/4" nps(f)	Steel pltd

Whip-End Fluid Hose Assemblies

Part Number	Bulk Hose No.	Size	Max. Working Pressure	Tube Material	Connection Type	Threads	Connection Material
71-8360	n/a	3/16" i.d. x 30"	3000 psi	Nylon	n/a	1/4" nps(f) x 1/4" npt(m)	Steel pltd
71-6844	n/a	1/8" i.d. x 3 ft.	5000 psi	Nylon	n/a	1/4" nps(f) x 1/4" npt(m)	Steel pltd

Air-assist Airless Fluid Hose Assemblies

Part Number	Bulk Hose No.	Size	Max. Working Pressure	Tube Material	Connection Type	Threads	Connection Material
71-4992	n/a	1/8" i.d. x 15 ft.	4000 psi	Nylon	n/a	1/4" npt(f)	s.s.
71-4993	n/a	1/8" i.d. x 25 ft.	5000 psi	Nylon	n/a	1/4" nps(f)	s.s.
71-4995	n/a	3/16" i.d. x 25 ft.	1900 psi	Nylon	n/a	1/4" nps(f)	s.s.

E.V.A. = Ethylene Vinyl Acetate E.P.D.M. = Ethylene Propylene Diene Rubber s.s. = stainless steel
 Steel pltd = Steel plated Brass pltd = Brass plated

Hose, Connections & Assemblies

FRP Hose Assemblies

Air Hose Assemblies (Low Pressure – FRP)

Part Number	Bulk Hose No.	Size	Max. Working Pressure	Tube Material	Connection Part No.	Threads	Connection Material
207-10752-1	237-505	1/4" i.d. x 1/2" o.d. x 14"	250 psi	E.V.A.	n/a	1/4"nps(f)x1/4"npt(m)	Brass
207-10752-2	237-505	1/4" i.d. x 1/2" o.d. x 20"	250 psi	E.V.A.	n/a	1/4"nps(f)x1/4"npt(m)	Brass
207-10752-4	237-505	1/4" i.d. x 1/2" o.d. x 28"	250 psi	E.V.A.	n/a	1/4"nps(f)x1/4"npt(m)	Brass
207-10752-5	237-505	1/4" i.d. x 1/2" o.d. x 16"	250 psi	E.V.A.	n/a	1/4"nps(f)x1/4"npt(m)	Brass
207-10752-6	237-505	1/4" i.d. x 1/2" o.d. x 72"	250 psi	E.V.A.	n/a	1/4"nps(f)x1/4"npt(m)	Brass
207-11512-1	71-227	1/4" i.d. x .350 o.d. x 5 ft.	225 psi	Nylon	72-1687	1/4"nps(f)	Brass pltd
207-11512-10	71-227	1/4" i.d. x .350 o.d. x 18 ft.	225 psi	Nylon	72-1687	1/4"nps(f)	Brass pltd
207-11512-3	71-227	1/4" i.d. x .350 o.d. x 25 ft.	225 psi	Nylon	72-1687	1/4"nps(f)	Brass pltd
207-11512-8	71-227	1/4" i.d. x .350 o.d. x 50 ft.	225 psi	Nylon	72-1687	1/4"nps(f)	Brass pltd
207-10770-2	71-11000	5/16" i.d. x 5/8" o.d. x 23 ft.	250 psi	EPDM	72-1317	1/4"nps(f)	Brass pltd
207-10770-8	71-11000	5/16" i.d. x 5/8" o.d. x 50 ft.	250 psi	EPDM	72-1317	1/4"nps(f)	Brass pltd

Fluid Hose Assemblies (Low Pressure)

Part Number	Bulk Hose No.	Size	Max. Working Pressure	Tube Material	Connection Part No.	Threads	Connection Material
207-10941-5	4282	1/2" i.d. x 50 ft.	2000 psi	Nylon	237-916	3/4" - 16 J.I.C. sw.	Steel pltd
207-10941-8	4282	1/2" i.d. x 30"	2000 psi	Nylon	237-916	3/4" - 16 J.I.C. sw.	Steel pltd
207-12269-2	71-283	1/2" i.d. x 7/8" o.d.	750 psi	Nylon	237-916	3/4" - 16 J.I.C. sw.	Steel pltd
207-12269-5	71-283	1/2" i.d. x 7/8" o.d.	750 psi	Nylon	237-916	3/4" - 16 J.I.C. sw.	Steel pltd
207-12347	71-223	1/4" i.d. x 3/8" o.d. x 8"	100 psi	Polyethylene	237-901/237-902	1/4"npt(m)	Polypropylene
207-10946-1	71-284	3/4" i.d. x 6 ft.	750 psi	Nylon	4358	1 1/16"-12 J.I.C. sw.	Steel pltd
207-10946-2	71-284	3/4" i.d. x 9 ft.	750 psi	Nylon	4358	1 1/16"-12 J.I.C. sw.	Steel pltd

E.V.A. = Ethylene Vinyl Acetate E.P.D.M. = Ethylene Propylene Diene Rubber s.s. = stainless steel
 Steel pltd = Steel plated Brass pltd = Brass plated

Hose, Connections & Assemblies

FRP Hose Assemblies

Misc. Air/Fluid Hose Assemblies (FRP)

Part Number	Bulk Hose No.	Size	Max. Working Pressure	Tube Material	Connection Part No.	Threads	Connection Material	Type
207-10910-6	4243	1/2" i.d. x 13/16" o.d. x 18"	200 psi	n/a	KF08-08PS	1/2" npt(m)	Brass pltd	Air
207-11016-2	71-280	1/4" i.d. x 20"	500 psi	Nylon	KF04-04RV x KF04-04PS	1/4" nps(f) x 1/4" npt(m)	Brass pltd	Air/fluid
207-11016-4	71-280	1/4" i.d. x 12"	500 psi	Nylon	KF04-04RV x KF04-04PS	1/4" nps(f) x 1/4" npt(m)	Brass pltd	Air/fluid

1/4" I.D. Fluid Hose Assemblies (High Pressure Airless, Wireless)

Part Number	Bulk Hose No.	Size	Max. Working Pressure	Tube Material	Connection Part No.	Threads	Connection Material
207-10769-1	n/a	1/4" i.d. x 5 ft.	3000 psi	Nylon	Permanent	9/16" - 18 J.I.C. sw.	n/a
207-10769-11	n/a	1/4" i.d. x 9 1/2"	3000 psi	Nylon	Permanent	9/16" - 18 J.I.C. sw.	n/a
207-10769-3	n/a	1/4" i.d. x 25 ft.	3000 psi	Nylon	Permanent	9/16" - 18 J.I.C. sw.	n/a
207-10769-5	n/a	1/4" i.d. x 35 ft.	3000 psi	Nylon	Permanent	9/16" - 18 J.I.C. sw.	n/a
207-10769-8	n/a	1/4" i.d. x 50 ft.	3000 psi	Nylon	Permanent	9/16" - 18 J.I.C. sw.	n/a
207-11382-3	n/a	1/4" i.d. x 25 ft.	3000 psi	Nylon	Permanent	9/16-18 J.I.C.(f) x 1/4" nps(f)	n/a
207-11382-8	n/a	1/4" i.d. x 50 ft.	3000 psi	Nylon	Permanent	9/16-18 J.I.C.(f) x 1/4" nps(f)	n/a
207-12120-2	n/a	1/4" i.d. x 30"	3000 psi	Nylon	Permanent	1/4" nps(f)	n/a
207-12120-3	n/a	1/4" i.d. x 17"	3000 psi	Nylon	Permanent	1/4" nps(f)	n/a

E.V.A. = Ethylene Vinyl Acetate E.P.D.M. = Ethylene Propylene Diene Rubber s.s. = stainless steel
 Steel pltd = Steel plated Brass pltd = Brass plated

Hose, Connections & Assemblies

Catalyst Hose Assemblies (FRP)

Recommended Use

For acid and peroxidized catalyst and other aqueous (water) solutions. Also recommended for use as a light weight, low pressure air hose. May be used for buffing compounds and concrete resurfacing materials.

Tube

EVA

Reinforcement

Single open braid, reyon/nylon

Cover

EVA – blue

Connections

Reuseable, stainless steel tailpiece and swivel, aluminum nut.

SIZES AVAILABLE		BULK HOSE NO.	MAXIMUM WORKING PRESSURE (psi)	NO. OF BRAIDS	APPROX. SHIPPING WEIGHT BASED ON FEET PER REEL	HOSE WEIGHT PER 100 FEET	CONNECTION	
i.d.	o.d.						THREAD	PART NO.
1/8	5/16	71-201	100	1	16	3.2	1/4"nps(f)	102-3031 SS316 ●
5/16	17/32	71-508	250	1	33.5	6.7	1/4"nps(f) 3/8"nps(f)	72-1646 SS416 ● 207-10383 SS416 ●
3/8	19/32	71-509	250	1	37.5	7.5	3/8"nps(f)	102-3040 s.s. 316

● These assemblies have connections with spring guards

Catalyst Hose Assemblies (Low Pressure)

Part Number	Bulk Hose No.	Size	Max. Working Pressure	Tube Material	Connection Part No.	Threads	Connection Material
207-12347	71-223	1/4" i.d. x 3/8" o.d. x 8"	100 psi	Polyethylene	237-901	1/4"npt(m)	Polypropylene
102-3028	71-201	1/8"i.d. x 5/16" o.d. x 25 ft.	100 psi	E.V.A.	102-3031	1/4"nps(f) sw.	316 s.s.
102-3029	71-201	1/8"i.d. x 5/16" o.d. x 35 ft.	100 psi	E.V.A.	102-3031	1/4"nps(f) sw.	316 s.s.
102-3030	71-201	1/8"i.d. x 5/16" o.d. x 50 ft.	100 psi	E.V.A.	102-3031	1/4"nps(f) sw.	316 s.s.
102-3028	71-201	1/8"i.d. x 5/16" o.d. x 25 ft.	100 psi	E.V.A.	102-3031	1/4"nps(f) sw.	316 s.s.
102-3029	71-201	1/8"i.d. x 5/16" o.d. x 35 ft.	100 psi	E.V.A.	102-3031	1/4"nps(f) sw.	316 s.s.
102-3030	71-201	1/8"i.d. x 5/16" o.d. x 50 ft.	100 psi	E.V.A.	102-3031	1/4"nps(f) sw.	316 s.s.
102-3034	71-201	1/8"i.d. x 5/16" o.d. x 30"	100 psi	E.V.A.	72-1573, 102-2653	1/4"nps(f) sw.	s.s.
102-3036	71-201	1/8"i.d. x 5/16" o.d. x 3'	100 psi	E.V.A.	72-1573, 102-2653	1/4"nps(f) sw.	s.s.
102-3035	71-509	3/8"i.d. x 19/32" o.d. x 3'	250 psi	E.V.A.	72-1367, 102-3033	3/8"nps(f) sw.	s.s.
71-2732	71-508	5/16" i.d. x 33/64" o.d. x 15'	250 psi	E.V.A.	72-1646	1/4"nps(f) sw.	s.s.
71-2734	71-508	5/16" i.d. x 33/64" o.d. x 25'	250 psi	E.V.A.	72-1646	1/4"nps(f) sw.	s.s.
71-2735	71-508	5/16" i.d. x 33/64" o.d. x 50'	250 psi	E.V.A.	72-1646	1/4"nps(f) sw.	s.s.

E.V.A. = Ethylene Vinyl Acetate

E.P.D.M. = Ethylene Propylene Diene Rubber

s.s. = stainless steel

Steel pltd = Steel plated

Brass pltd = Brass plated

Hose, Connections & Assemblies

Catalyst Hose Assemblies (FRP)

3/16" I.D. Fluid Hose Assemblies (High Pressure Catalyst)

Part Number	Bulk Hose No.	Size	Max. Working Pressure	Tube Material	Connection Part No.	Threads	Connection Material
107-1465	n/a	3/16" i.d. x 3/8" o.d. x 50 ft.	2500 psi	Teflon/ s.s.	Permanent	7/16" - 20 (f) sw.	Steel pltd
207-12305-1	n/a	3/16" i.d. x 5/16" o.d. x 20"	3000 psi	Teflon/ s.s.	Permanent	7/16"-20 J.I.C. sw.	s.s.
207-12305-3	n/a	3/16" i.d. x 5/16" o.d. x 38"	3000 psi	Teflon/ s.s.	Permanent	7/16"-20 J.I.C. sw.	s.s.
207-12305-4	n/a	3/16" i.d. x 5/16" o.d. x 25 ft.	3000 psi	Teflon/ s.s.	Permanent	7/16"-20 J.I.C. sw.	s.s.
207-12305-5	n/a	3/16" i.d. x 5/16" o.d. x 45 ft.	3000 psi	Teflon/ s.s.	Permanent	7/16"-20 J.I.C. sw.	s.s.
207-12305-7	n/a	3/16" i.d. x 5/16" o.d. x 35 ft.	3000 psi	Teflon/ s.s.	Permanent	7/16"-20 J.I.C. sw.	s.s.
207-12305-8	n/a	3/16" i.d. x 5/16" o.d. x 1 ft.	3000 psi	Teflon/ s.s.	Permanent	7/16"-20 J.I.C. sw.	s.s.
207-12305-9	n/a	3/16" i.d. x 5/16" o.d. x 17"	3000 psi	Teflon/ s.s.	Permanent	7/16"-20 J.I.C. sw.	s.s.

E.V.A. = Ethylene Vinyl Acetate E.P.D.M. = Ethylene Propylene Diene Rubber s.s. = stainless steel
 Steel pltd = Steel plated Brass pltd = Brass plated

Fittings

ADAPTERS	6-2
SWIVEL CONNECTIONS	6-2
SWIVEL ADAPTERS	6-3
SWIVEL UNIONS	6-3
BULKHEAD UNION ELBOWS	6-3
REDUCING BUSHINGS	6-4
NIPPLES & REDUCING NIPPLES	6-4
ELBOWS	6-7
MISC. CONNECTIONS	6-8
TEES & CROSSES	6-8
PIPE PLUGS	6-9
QUICK DISCONNECTS	6-10

Fittings

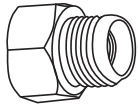

Adapters

Part Number	Description	Materials	Max. Working Pressure	Inlet	Outlet
LOW PRESSURE					
72-54	Adapter	Brass pltd	250 psi	1/4" nps(f)	3/8" nps(m)
73-131	Adapter	Brass pltd	250 psi	1/4" nps(m)	1/4" nps(f)
72-55	Adapter	Brass pltd	250 psi	1/4" nps(m)	3/8" nps(f)
73-130	Adapter	Brass pltd	250 psi	3/8" nps(m)	3/8" nps(f)
85-851	Adapter	Brass pltd	250 psi	3/8-24 unf	1/8" npt(m)
HIGH PRESSURE					
207-10699	Adapter	303 s.s.	3500 psi	1/4" nps(m)	1/4" npt(f)
72-727	Adapter	303 s.s.	4000 psi	1/8" npt(f)	1/4" nps(m)
72-731	Adapter	Steel pltd	5000 psi	3/8" npt(f)	1/4" nps(m)



73-18

Swivel Connections (90°)

Part Number	Description	Materials	Max. Working Pressure	Inlet	Outlet
LOW PRESSURE					
72-989	Swivel ass'y 90 deg. 5, 10 & 15 Gal tanks, single tank outlet	Steel	250 psi	3/8" npt(f)	7/8-18 (f)
73-16	Swivel connection	Brass	250 psi	3/8" nps(f)	3/8" nps(f)
73-18	Elbow swivel 90 deg.	Brass pltd	250 psi	1/4" nps(m)	3/8" nps(f)
HIGH PRESSURE					
72-918	Connection 90 deg.	Steel	4000 psi	1/4" npt(f)	1/4" nps(f)
103-1238	Swivel connection	316 s.s.	4000 psi	1/4" npt(m)	3/8" nps(f)
73-24	Elbow swivel 90 deg.	303 s.s.	3000 psi	3/8" nps(m)	3/8" nps(f)
SSP-57-ZN	90° Swivel connection	Steel pltd	4000 psi	3/8" npt(m)	3/8" nps(f)
NON-RATED					
72-994	Double swivel asm 60 gal tank, double tank outlet	Brass pltd	200 psi	7/8-18" nps(f)	(2) 3/8" npt(f)

N/R = Non-Rated • Pltd brass = Plated brass, chrome • S.S. = Stainless steel
Galv. = Galvanized steel • Steel pltd = Plated steel, cadmium or zinc • Poly = Polypropylene plastic

Fittings

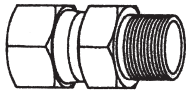

Swivel Adapters (Straight)

Part Number	Description	Materials	Max. Working Pressure	Inlet	Outlet
SSP-8217-ZN	Swivel adapter	Steel pltd	4000 psi	1/4" nps(f)	1/4" npt(m)
103-1238	Swivel adapter	s.s.	4000 psi	1/4" npt(m)	3/8" nps(f)
72-2332	Swivel adapter	Steel pltd	7500 psi	1/4" nps(m)	1/4" nps(f)
72-2333	Swivel adapter	Steel pltd	7500 psi	3/8" nps(m)	1/4" nps(f)
20-4281	Swivel adapter	Steel pltd	4000 psi	3/8" npt(m)	3/8" nps(f)
0114-016058	Swivel adapter	Steel	4000 psi	3/8 bspt(m)	3/8 bspp(f)
20-4283	Swivel adapter	Steel pltd	3500 psi	1/2" npt(m)	1/2" nps(f)

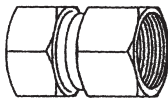

Swivel Unions

Part Number	Description	Materials	Max. Working Pressure	Inlet	Outlet
72-1253	Swivel union	Steel pltd	4000 psi	3/8" npt(f)	1/4" nps(f)
83-1935	Swivel union	Steel pltd	4000 psi	1/4" npt(f)	1/4" nps(f)
102-2126	Swivel union	303 s.s.	3000 psi	1/4" npt(f)	1/4" nps(f)

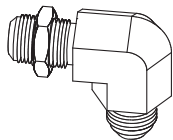

Bulkhead Union Elbows

Part Number	Description	Materials	Max. Working Pressure	Inlet	Outlet
107-1641	Bulkhead union elbow	316 s.s.	5000 psi	#4 J.I.C. (m)	7/16"-28 #4 J.I.C. (m)
107-1642	Bulkhead union elbow	Steel, zinc pltd	5000 psi	#8 J.I.C. (m)	3/4"-16 #8 J.I.C. (m)

N/R = Non-Rated • Pltd brass = Plated brass, chrome • S.S. = Stainless steel
Galv. = Galvanized steel • Steel pltd = Plated steel, cadmium or zinc • Poly = Polypropylene plastic

Fittings

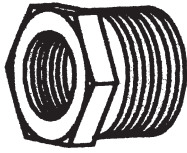

Reducing Bushings

Part Number	Description	Materials	Max. Working Pressure	Inlet	Outlet
LOW PRESSURE					
20-2154	Bushing	Steel	150 psi	1-1/2" npt(m)	1" npt(f)
20-2525	Bushing	Galv.	250 psi	3/4" npt(m)	1/2" npt(f)
HIGH PRESSURE					
20-3809-1	Bushing	Steel pltd	4000 psi	1/2" npt(m)	1/4" npt(f)
20-3815	Bushing	304 s.s.	3000 psi	1/2" npt(m)	3/8" npt(f)
20-3823-1	Bushing	Steel pltd	3000 psi	1/2" npt(m)	3/8" npt(f)
20-4924	Bushing	Steel pltd	3000 psi	1-1/4" npt(m)	1" npt(f)
237-614	Bushing	Steel	4000 psi	3/4" npt(f)	1" npt(m)
20-4347	Bushing	Steel pltd	3000 psi	3/4" npt(m)	3/8" npt(f)
20-1753-1	Bushing	Steel pltd	4000 psi	3/8" npt(m)	1/4" npt(f)
20-3083	Bushing	316 s.s.	4000 psi	3/8" npt(m)	1/4" npt(f)

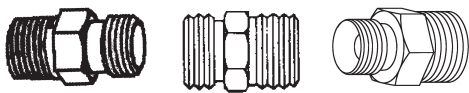

Nipples & Reducing Nipples

Part Number	Description	Materials	Max. Working Pressure	Inlet	Outlet
LOW PRESSURE					
SSP-462-ZN	D.M. Nipple	Steel pltd	750 psi	1/4" npt(m)	1/4" npt(m)
72-423	D.M. Nipple	Brass pltd	500 psi	1" npt(m)	1" nps(m)
83-1823	D.M. Nipple	Brass	500 psi	1/2" npt(m)	1/2" nps(m)
72-1243	D.M. Nipple	Brass pltd	500 psi	1/2" npt(m)	1/2" nps(m)
H-2008	Nipple	Brass pltd	750 psi	1/4" nps(m)	1/4" npt(m)
83-1050	D.M. Nipple	Brass	750 psi	1/4" nps(m)	1/4" nps(m)
AD-31	D.M. Nipple	Brass pltd	750 psi	1/4" nps(m)	1/4" nps(m)
AD-26	Reducing nipple	Brass pltd	750 psi	1/4" nps(m)	3/8" nps(m)

N/R = Non-Rated • Pltd brass = Plated brass, chrome • S.S. = Stainless steel
Galv. = Galvanized steel • Steel pltd = Plated steel, cadmium or zinc • Poly = Polypropylene plastic

Fittings

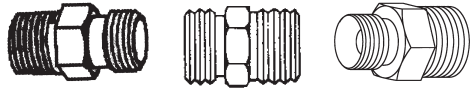

Nipples & Reducing Nipples

Part Number	Description	Materials	Max. Working Pressure	Inlet	Outlet
LOW PRESSURE (continued)					
57-13-1	D.M. Nipple	Brass pltd	750 psi	1/4" npt(m)	1/4" nps(m)/bspp(m)
83-576	D.M. Nipple	Brass	750 psi	1/4" npt(m)	1/4" nps(m)
H-209	D.M. Nipple	Brass pltd	750 psi	1/4" npt(m)	9/16-20 (m)
71-28	Reducing nipple	Brass pltd	750 psi	1/8" npt(m)	1/4" nps(m)
83-1822	D.M. Nipple	Brass pltd	750 psi	3/4" nps(m)	3/4" nps(m)
83-1294	D.M. Nipple	Brass pltd	750 psi	3/8" nps(m)	3/8" nps(m)
AD-11	D.M. Nipple	Brass pltd	750 psi	3/8" npt(m)	3/8" nps(m)
83-1185	D.M. Nipple	Brass pltd	750 psi	3/8" npt(m)	3/8" npt(m)
HIGH PRESSURE					
237-859	D.M. Nipple	316 s.s.	6000 psi	#3 J.I.C. (m)	#3 J.I.C. (m)
107-1635	D.M. Nipple	316 s.s.	6000 psi	#3 J.I.C. (m)	1/8" npt(m)
237-871	D.M. Nipple	316 s.s.	5000 psi	#4 J.I.C. (m)	#4 J.I.C. (m)
107-1439	D.M. Nipple	316 s.s.	5000 psi	#4 J.I.C. (m)	1/4" npt(m)
72-1374	D.M. Nipple	Steel pltd	3500 psi	1" npt(m)	1" npt(m)
72-1981	D.M. Nipple	Steel pltd	3500 psi	1" npt(m)	1" nps(m)
41-1235	D.M. Nipple	303 s.s.	2500 psi	1/2" nps(m)	1/2" nps(m)
237-266	D.M. Nipple	Steel	6000 psi	1/2" npt(m)	1/2" npt(m)
237-374	Reducing nipple	Steel	6000 psi	1/2" npt(m)	3/8" npt(m)
72-1316	Reducing nipple	Steel pltd	4000 psi	1/2" npt(m)	3/4" npt(m)
72-791	D.M. Nipple	303 s.s.	4500 psi	1/4" nps(m)	1/4" nps(m)
72-691	D.M. Nipple	Steel pltd	6000 psi	1/4" nps(m)	1/4" nps(m)
101-1772	Reducing nipple	316 s.s.	5000 psi	1/4" nps(m)	1/8" npt(m)
72-1888	Reducing nipple	Steel pltd	6000 psi	1/4" nps(m)	3/8" nps(m)
72-988	Reducing nipple	303 s.s.	4500 psi	1/4" nps(m)	3/8" npt(m)
72-1268	Reducing nipple	Steel pltd	5000 psi	1/4" npt(m)	3/8" npt(m)
72-790	D.M. Nipple	316 s.s.	4500 psi	1/4" npt(m)	1/4" nps(m)
72-690	D.M. Nipple	Steel pltd	6000 psi	1/4" npt(m)	1/4" nps(m)
20-4854	D.M. Nipple	316 s.s.	6000 psi	1/4" npt(m)	1/4" npt(m)
83-2484	Reducing nipple	303 s.s.	3000 psi	1/4" npt(m)	3/8" nps(m)

N/R = Non-Rated • Pltd brass = Plated brass, chrome • S.S. = Stainless steel
Galv. = Galvanized steel • Steel pltd = Plated steel, cadmium or zinc • Poly = Polypropylene plastic

Fittings

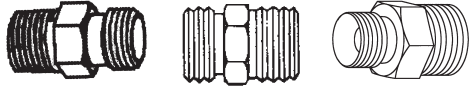

Nipples & Reducing Nipples

Part Number	Description	Materials	Max. Working Pressure	Inlet	Outlet
HIGH PRESSURE (continued)					
237-375	Nipple	Steel pltd	6000 psi	1/4" npt(m)	1/4" npt(m)
83-4233	Reducing nipple	Steel pltd	6000 psi	1/4" npt(m)	3/8" npt(m)
H-1580-H	Reducing nipple	s.s.	3000 psi	1/4" npt(m)	3/8" nps(m) / bsp (m)
72-792	Reducing nipple	303 s.s.	5000 psi	1/8" npt(m)	1/4" nps(m)
72-969	Reducing nipple	303 s.s.	3000 psi	1/8" npt(m)	3/8" nps(m)
HGS-22	Reducing nipple	s.s.	3000 psi	1/8" npt(m)	1/4" nps(m)
HGS-21	Reducing nipple	s.s.	3000 psi	1/8" npt(m)	3/8" nps(m)
72-1770	D.M. Nipple	303 s.s.	2000 psi	3/4" npt(m)	3/4" nps(m)
72-1102	D.M. Nipple	Steel pltd	4000 psi	3/4" npt(m)	3/4" npt(m)
101-713	D.M. Nipple	Steel, 3 1/2" long	5000 psi	3/4" npt(m)	3/4" nps(m)
72-798	D.M. Nipple	303 s.s.	4500 psi	3/8" nps(m)	3/8" nps(m)
72-1933	Reducing nipple	303 s.s.	5000 psi	3/8" npt(m)	1/2" nps(m)
83-2055	D.M. Nipple	303 s.s.	4500 psi	3/8" npt(m)	3/8" nps(m)
72-998	D.M. Nipple	Steel pltd	3000 psi	3/8" npt(m)	3/8" npt(m)
SSP-459	D.M. Nipple	316 s.s.	6000 psi	3/8" npt(m)	3/8" npt(m)
107-1449	Reducing nipple	s.s.	5000 psi	#4 J.I.C. (m)	1/8" npt(m)
207-12349	Reducing nipple	303 s.s.	4000 psi	#4 J.I.C. (m)	3/8-24 unf (m)
107-1082	Reducing nipple	Steel pltd	6000 psi	#8 J.I.C. (m)	1/4" nps(m)

N/R = Non-Rated • Pltd brass = Plated brass, chrome • S.S. = Stainless steel
Galv. = Galvanized steel • Steel pltd = Plated steel, cadmium or zinc • Poly = Polypropylene plastic

Fittings

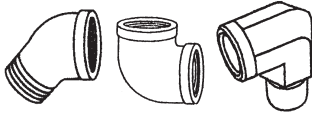

Elbows

Part Number	Description	Materials	Max. Working Pressure	Inlet	Outlet
LOW PRESSURE					
20-6	Elbow 90 deg.	Blk. Iron	150 psi	1" npt(f)	1" npt(f)
20-99	Elbow street 90 deg.	Blk. Iron	150 psi	1" npt(f)	1" npt(m)
20-3340-1	Elbow street 90 deg.	Brass pltd	250 psi	1/2" npt(m)	1/2" npt(f)
237-250	Elbow 90 deg.	Brass	150 psi	1/4" npt(m)	1/4" tube
237-902	Elbow 90 deg.	Poly	150 psi	1/4" npt(m)	3/8" tube
86-563	Elbow street 90 deg.	Brass pltd	250 psi	1/4" npt(m)	1/4" npt(f)
207-11918	Elbow, inlet	Poly	150 psi	1/8" npt(m)	1/4" o.d. tube
237-528	Elbow 90 deg.	Poly	150 psi	1/8" npt(m)	1/4" o.d. tube
20-3645	Elbow street 90 deg.	Brass pltd	250 psi	1/8" npt(m)	1/8" npt(f)
237-572	Elbow 45 deg.	Brass	250 psi	1/8" npt(m)	#5 J.I.C. (m)
237-247	Elbow 90 deg.	Brass	250 psi	1/8" npt(m)	1/4" hose
HIGH PRESSURE					
237-743	Elbow 90 deg.	s.s.	3000 psi	1" npt(m)	1" o.d. tube
20-3590	Elbow street 90 deg.	s.s.	3000 psi	3/4" npt(m)	3/4" npt(f)
237-276	Reducing elbow 90 deg.	Steel pltd	6000 psi	1/2" npt(f)	#6 J.I.C. (m)
20-3821	Elbow street 90 deg.	Steel pltd	3000 psi	3/8" npt(m)	3/8" npt(f)
20-2848	Elbow 90 deg.	304 s.s.	4000 psi	1/4" npt(f)	1/4" npt(f)
107-1636	Elbow 90 deg.	316 s.s.	8000 psi	1/4" npt(m)	1/4" o.d. tube
101-1770	Elbow street 90 deg.	316 s.s.	7200 psi	1/4" npt(m)	1/4" npt(f)
237-263	Elbow street 90 deg.	n/r	5000 psi	1/4" npt(m)	1/4" npt(f)
107-1646	Elbow 90 deg.	316 s.s.	5000 psi	1/8" npt(m)	#4 J.I.C. (m)
237-767	Elbow street 45 deg.	Brass	5000 psi	1/4" npt(m)	1/4" npt(f)
207-12085	Reducing elbow 90 deg.	s.s.	6000 psi	#4 J.I.C. (m)	1/2" nps(f) sw.
237-295	Reducing elbow 90 deg.	Steel	3000 psi	#12 J.I.C.	3/4" npt(f)

N/R = Non-Rated • Pltd brass = Plated brass, chrome • S.S. = Stainless steel
Galv. = Galvanized steel • Steel pltd = Plated steel, cadmium or zinc • Poly = Polypropylene plastic

Fittings

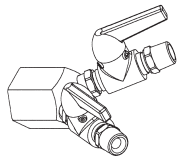

83-2155

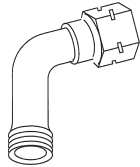

P-H-431, P-H-432

Misc. Connections

Part Number	Description	Materials	Max. Working Pressure	Inlet	Outlet
LOW PRESSURE					
P-H-432	Fitting	n/a	750 psi	3/8" nps(f) sw	3/8" nps(m)
72-1869	Circulating connection	s.s.	1000 psi	(2) 1/4" nps(m)	3/8" nps(f) sw
P-H-431	Fitting	n/a	750 psi	1/4" nps(f) sw	1/4" nps(m)
237-901	Connection	Poly	150 psi	1/4" npt(m)	3/8 tube
85-85	Air tube connection	Brass pltd	250 psi	1/8" npt(m)	3/8-24 unf (f)
SSP-6102-K5	Fitting, 90 deg. Barbed	Brass	250 psi	1/8" npt(m)	.170 i.d. tube
4358	Fitting	n/a	750 psi	#12 J.I.C. (f) sw	3/4 i.d. hose
HIGH PRESSURE					
83-2155	Double outlet manifold	303 s.s.	4000 psi	1" npt(f)	3/8" npt(m)
107-1625	Fitting	316 s.s.	6600 psi	1/4" npt(f)	1/4 o.d. tube

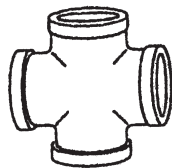
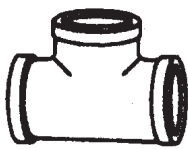

Tees & Crosses

Part Number	Description	Type	Max. Working Pressure	Inlet	Outlet
20-4593	Cross	Steel	3000 psi	1/2" npt(f) all ports	1/2" npt(f) all ports
237-280	male run tee	Steel pltd	3000 psi	1/2" npt(m)	(2) 1/2" npt(f)
101-2050	Tee	316 s.s.	3000 psi	1/4" npt(f) all ports	1/4" npt(f) all ports
237-914	Street tee	316 s.s.	3000 psi	1/4" npt(m)	(2) 1/4" npt(f)
SSP-2629-ZN	Branch tee	Steel pltd	5000 psi	1/4" npt(m)	(2) 1/4" npt(f)

N/R = Non-Rated • Pltd brass = Plated brass, chrome • S.S. = Stainless steel
Galv. = Galvanized steel • Steel pltd = Plated steel, cadmium or zinc • Poly = Polypropylene plastic

Fittings



Pipe Plugs – Internal Hex & Square Head

Part Number	Description	Materials	Max. Working Pressure	Inlet	Type
HIGH PRESSURE					
20-5692	Pipe plug	Steel pltd	4000 psi	1/16"npt(m)	Hex
20-5051	Pipe plug	s.s.	4000 psi	1/16"npt(m)	Hex
20-3111	Pipe plug	303 s.s.	4000 psi	1/8"npt(m)	Hex
20-2287-1	Pipe plug	Steel pltd	4000 psi	1/8"npt(m)	Hex
20-6131	Pipe plug	s.s.	4000 psi	1/4"npt(m)	Hex
20-2288-1	Pipe plug	Steel pltd	4000 psi	1/4"npt(m)	Hex
20-4401	Pipe plug	303 s.s.	4000 psi	1/4"npt(m)	Square head
20-6739	Pipe plug	s.s.	4000 psi	1/4"npt(m)	Hex
86-558	Pipe plug	Steel pltd	4000 psi	1/4"npt(m)	Square head
237-338	Pipe plug	Steel pltd	4000 psi	1/4"npt(m)	Hex
237-774	Pipe plug	s.s.	4000 psi	1/4"npt(m)	Hex
20-1592	Pipe plug	Galv.	4000 psi	3/8"npt(m)	Square head
20-2097	Pipe plug	Steel	4000 psi	1/2"npt(m)	Hex
NON-RATED					
237-336	Pipe plug	Steel	n/r	1/16"npt(m)	Hex
237-879	Pipe plug	Steel	n/r	2"npt(m)	Bung

N/R = Non-Rated • Pltd brass = Plated brass, chrome • S.S. = Stainless steel
Galv. = Galvanized steel • Steel pltd = Plated steel, cadmium or zinc • Poly = Polypropylene plastic

Fittings

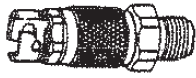

Quick Disconnects – Bayonett Style (Fluid)

Part Number	Type	Description	Connection	Service Form
72-1804	Body (f)	Stainless steel	3/8" nps(m)	n/a
72-364	Stem (m)	Stainless steel	3/8" nps(f)	n/a
P-HC-4808-1	Body (f)	Aluminum	3/8" nps(m)	SB-12-001
P-HC-4482	Stem (m)	Hardened Steel	3/8" nps(f)	SB-12-001
HC-513-1	Body (f)	Stainless steel	3/8" nps(m)	SB-12-001
QDL-4808	Body (f)	Delrin/Stainless	3/8" nps(m)	SB-12-001
HC-4691	Stem (m)	Stainless steel	3/8" nps(f) swivel	SB-12-001



Quick Disconnects – Fluid (Solvent Based)

Part Number	Type	Description	Connection Size	Service Form
72-885	Body (f)	Steel	3/8" nps(m)	n/a
72-896	Body (f)	Steel	3/8 i.d. hose	n/a
72-887	Stem (m)	Steel	3/8" nps(f)	n/a

Quick Disconnect Assemblies – Fluid (Solvent Based)

Part Number	Description	Service Form
72-888	72-885 Body 72-887 Stem	n/a



High Pressure Swivel Connection

Part Number	Description	Materials	Max. Working Pressure	Inlet	Outlet
72-780	Swivel connection	Steel	3000 psi	1/4" nps(m)	1/4" nps(f)

N/R = Non-Rated • Pltd brass = Plated brass, chrome • S.S. = Stainless steel
Galv. = Galvanized steel • Steel pltd = Plated steel, cadmium or zinc • Poly = Polypropylene plastic

Fittings



Quick Disconnects – Air

Part Number	Type	Description	Connection Size	Service Form
72-2063	Body (f)	Standard	1/4" nps(m)	n/a
72-2066	Body (f)	Standard	5/16 i.d. hose	n/a
72-2073	Body (f)	Standard	1/4" npt(f)	n/a
72-445	Stem (m)	Standard	1/4" nps(f)	n/a
72-467	Stem (m)	Standard	1/4" npt(m)	n/a

Quick Disconnect Assemblies – Air

Obsolete Part Number	Order:	Description	Service Form
72-2076	72-2063 Body	72-445 Stem	n/a
72-470	72-2063 Body	72-467 Stem	n/a
72-474	72-2073 Body	72-445 Stem	n/a
72-476	72-2073 Body	72-467 Stem	n/a

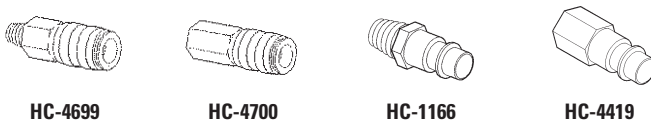

Quick Disconnects – Air (High-Flow)

Part Number	Type	Description	Connection Size	Service Form
HC-4699	Body (f)	Hi-flow	1/4 universal (m)	SB-12-001
HC-4700	Body (f)	Hi-flow	1/4" npt(f)	SB-12-001
HC-1166	Stem (m)	Hi-flow	1/4" npt(m)	SB-12-001
HC-4419	Stem (m)	Hi-flow	1/4" nps(f)	SB-12-001



Quick Disconnect Assemblies (High Pressure)

Part Number	Type	Description	Max. Working Pressure	Connection Size	Service Form
237-358	Body (f)	Steel pltd	3700 psi max	1/4" npt(f)	n/a
237-359	Stem (m)	Steel pltd	3700 psi max	1/4" npt(f)	n/a

N/R = Non-Rated • Pltd brass = Plated brass, chrome • S.S. = Stainless steel
Galv. = Galvanized steel • Steel pltd = Plated steel, cadmium or zinc • Poly = Polypropylene plastic

Air Supply Controls & Gauges

AIR REGULATORS	7-2
BYPASS AIR REGULATORS	7-4
CENTRIFUGAL AIR FILTERS / REGULATORS	7-6
COALESCER UNITS	7-8
DESICCANT UNITS	7-10
1 STAGE CHARCOAL FILTER	7-12
3 STAGE BREATHING AIR UNIT	7-12
2 STAGE FILTER / REGULATOR	7-12
FILTER ELEMENT KITS	7-14
AIR VIZOR™ BREATHABLE AIR SYSTEMS	7-14
VALVES	7-15
AIR PRESSURE GAUGES	7-16

Air Supply Controls & Gauges

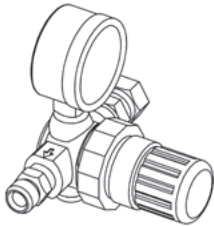

HAR Air Regulators

General purpose regulators for line takeoff use or as integral regulators on pumps, pressure tanks and other air operated devices. Require separate trap or filter in air line to remove moisture or dirt.

- Removable plug and cap.
- All metal body; durable Delrin® cap, metal T handle; Buna N diaphragm and disc.
- Accurate regulator mechanism provides precision air control.
- Self-relieving design.
- Both main line and regulated outlets available from same units.



HAR-501

HAR-501® Air Regulator

Extra Sensitive regulator for use with precision control on pressure feed tanks or other dead-end applications. Can be used to control atomization pressure for one spray gun.

- Self-relieving regulator.
- Tough, reinforced Buna N diaphragm for extended service life.
- 100 mesh stainless steel strainer.
- Removable bottom plug for easy service.
- Forged brass body and stainless steel or brass internal parts for long service.
- High ratio of diaphragm surface to orifice area provides stable uniform regulation.

Air Regulators

Part Number	Description	Inlet	Outlet(s)	Inlet Press. Min.	Outlet Press. Min.	Outlet Press. Max.
107-1342	Air regulator	1/4" npt(f)	2 ea 1/4" npt(f) 1 1/8" npt(f)	n/a	0 psi	60 psi
107-1343	Air regulator	3/4" npt(f)	1 ea 3/4" npt(f) 2 ea 1/4" npt(f)	250 psi	5 psi	125 psi
873465	Air regulator	1/4" npt(f)	3 ea 1/4" npt(f)	n/a	0 psi	125 psi
873466	Air regulator	1/4" npt(f)	3 ea 1/4" npt(f)	n/a	0 psi	50 psi
85-214	Air regulator (diaphragm)	1/4" npt(f)	3 ea 1/4" npt(f) Regulated	n/a	0 psi	100 psi
HAR-507	Air regulator (diaphragm)	3/8" npt(f)	3 ea 1/4" npt(f)	150 psi	0 psi	125 psi
HAR-535	Air regulator	3/8" npt(f)	1/4" npt(f) Unregulated 1/4" npt(f) Regulated 3/8" npt(f) Regulated	250 psi	0 psi	125 psi
HAR-555	Air regulator	3/8" npt(f)	2 ea 1/4" npt(f) Unregulated 1 ea 1/2" npt(f) Regulated	250 psi	0 psi	125 psi
HAR-600	Air regulator w/ gauge (diaphragm)	3/8" npt(f)	3 ea 1/4" npt(f)	150 psi	0 psi	125 psi
HARG-510	Air regulator w/ gauge (diaphragm)	1/4" nps(m)	1/4" nps(f) SWIVEL	300 psi	5 psi	100 psi
237-635	Air regulator	1/2" npt(f)	2 ea 1/4" npt 1 ea 1/2" npt(f)	n/a	0 psi	125 psi
JGHV-453 / KK-4980	Air regulator (mini) regulator kit	1/4" npt(f)	1 ea 1/4" npt(f) 1 ea 1/8" npt(f)	125 psi	0 psi	8 psi
HAR-501	Air regulator (extra sensitive)	3/8" npt(f)	3/8" npt(f)	250 psi	0 psi	20 psi
849303	Piggyback filter / air regulator	1/2" npt(f)	1/2" npt(f)	175 psi	0 psi	160 psi

HAR-400 Regulator Lockout Accessory

Used with any HAR, T Handle style air regulators.

This device allows the painter to set their air regulators to guarantee proper atomization, as well as to assure compliance in areas where air cap pressure is limited to 10 psi or less. Includes one key per unit.

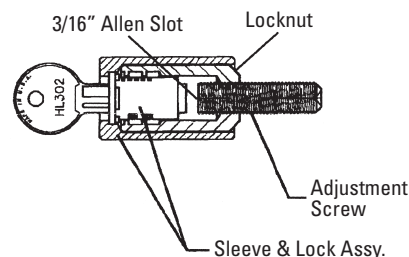

Air Supply Controls & Gauges

Air Regulators

Part Number	Capacity	Type	Gauge	Repair Kit	Service Form
107-1342	n/a	Knob	Optional 59-369 gauge 0-60	n/a	n/a
107-1343	n/a	Knob	None	None	77-2315
873465	n/a	Knob	Optional 849306 gauge 0-160	None	None
873466	n/a	Knob	Optional 849314 gauge 0-60	None	None
85-214	30 cfm	Knob	Optional 83-2727 gauge 0-100	6-207	77-1890
HAR-507	60 cfm	T-Handle	Optional GA-288 gauge 0-160	KK-4977	SB-6-147
HAR-535	40 cfm	T-Handle	Optional GA-33 gauge 0-30 or GA-333 gauge 0-100 or GA-288 gauge 0-160	KK-4139-3	SB-6-162
HAR-555	40 cfm	T-Handle	None	KK-4139-3	SB-6-162
HAR-600	60 cfm	T-Handle	Includes GA-288 gauge 0-160	KK-4977	SB-6-147
HARG-510	n/a	Knob	Includes GA-338 gauge 0-160	KK-4887-2	SB-6-105
237-635	100 cfm	T-Handle	Optional 83-1290 gauge 0 - 150 psi	237-904	77-2787
JGHV-453 / KK-4980	n/a	Knob	Optional GA-355 gauge 0-30 psi	n/a	SB-6-102
HAR-501	15 cfm	T-Handle	None	KK-4200	SB-6-131
849303	140 scfm	Knob	Includes 849306 gauge 0-160	849305	849303

Air Supply Controls & Gauges

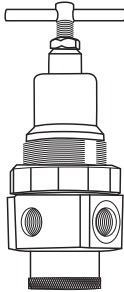

Bypass Air Regulators

Part Number	Description	Inlet	Outlet(s)	Inlet Press. Min.	Outlet Press. Min.	Outlet Press. Max.
85-215	Air regulator	1/4" npt(f)	2 ea 1/4" npt(f) regulated 1 ea 1/4" npt(f) unregulated	n/a	0 psi	100 psi
85-435	Air regulator kit	1/4" nps(m)	1 ea 1/4" nps(m) unregulated 1 ea 3/8"-24 (m) regulated 2 ea 1/8" npt(f) regulated	95 psi	0 psi	15 psi
85-440	Air regulator	1/2" npt w/ 1/4" nps(m) conn	1/8" npt(f) unregulated w/ 1/4" nps(f) swivel 1/8" npt(f) regulated w/ 7/16-24 (m) conn 1/8" npt(f) regulated w/ 85-70 gauge 1/8" npt(f) regulated w/ 85-243 55 psi safety valve	95 psi	0 psi	50 psi
85-445	Air regulator	1/2" npt w/ 1/4" nps(m) conn	1/8" npt(f) unregulated w/ 1/4" nps(f) swivel 1/8" npt(f) regulated w/ 3/8-24 (f) conn 1/8" npt(f) regulated w/ 85-70 gauge 1/8" npt(f) regulated w/ 85-243 55 psi safety valve	95 psi	0 psi	50 psi
HAR-511	Air regulator	3/8" npt(f)	1/4" npt(f) regulated 3/8" npt(f) regulated 2 1/4" npt(f) unregulated	150 psi	0 psi	125 psi
HAR-508	Air regulator	1/2" npt(f)	2 ea regulated 1/4" npt(f) 1 ea 1/2" npt(f) unregulated	300 psi	0 psi	160 psi

7

HAR-400 Regulator Lockout Accessory

Used with any HAR, T Handle style air regulators.

This device allows the painter to set their air regulators to guarantee proper atomization, as well as to assure compliance in areas where air cap pressure is limited to 10 psi or less. Includes one key per unit.

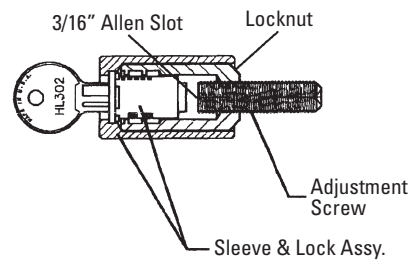

Air Supply Controls & Gauges

Bypass Air Regulators

Part Number	Capacity	Type	Gauge	Repair Kit	Service Form
85-215	30 cfm	Knob	Optional 83-2727 gauge 0-100	6-207	77-1890
85-435	n/a	Knob	Includes GA-313 gauge 0-15 plus 35 psi safety valve	KK-4887-2	77-2816
85-440	n/a	Knob	Includes 85-70 gauge 0-60 plus 35 psi safety valve	85-186	77-2417
85-445	n/a	Knob	Includes 85-70 gauge 0-60 plus 35 psi safety valve	85-186	77-2417
HAR-511	60 cfm	T-handle	Optional 83-1290 gauge 0-150	KK-4977	77-2781
HAR-508	28 cfm @ 60 psi	Knob	Optional GA-316 gauge 0-160	KK-5045	SB-6-133

Air Supply Controls & Gauges

DeVilbiss offers a complete line of quality air filtering units

It's the equipment you need to ensure a contaminant-free material application — because today's high solids and waterbornes are even more sensitive to contaminants. The right filter equipment from DeVilbiss can make all the difference.

The fact is, an otherwise great finish can be totally ruined by just a small amount of dirt, oil or water in your air line. And needless to say, flaws like pinholes, blushing, fisheyes or dulling mean a job has to be redone—a waste of both time and money.

Quality Equipment and Proper Installation

Following some key installation principles will help decrease the risk of contaminants:

- It's important to use the right size air compressor for your application. An overworked air compressor can produce a significant amount of dirt and oil.

- Proper piping is very important to help prevent condensation from forming within the line and contaminating the air supply.

DeVilbiss is ready to assist you with any questions.



Centrifugal Air Filters

Part Number	Description	Inlet	Outlet(s)	Inlet Press. Max.	Outlet Press. Min.	Outlet Press. Max.
HAF-502	Centrifugal air filter	1/2" npt(f)	1/2" npt(f)	150 psi	0 psi	150 psi
HAF-503	Centrifugal air filter	3/4" npt(f)	3/4" npt(f)	150 psi	0 psi	150 psi
HAF-505	Coalescing air filter	1/2" npt(f)	1/2" npt(f)	150 psi	0 psi	150 psi

Air Supply Controls & Gauges

Recommended Air Supply Setup

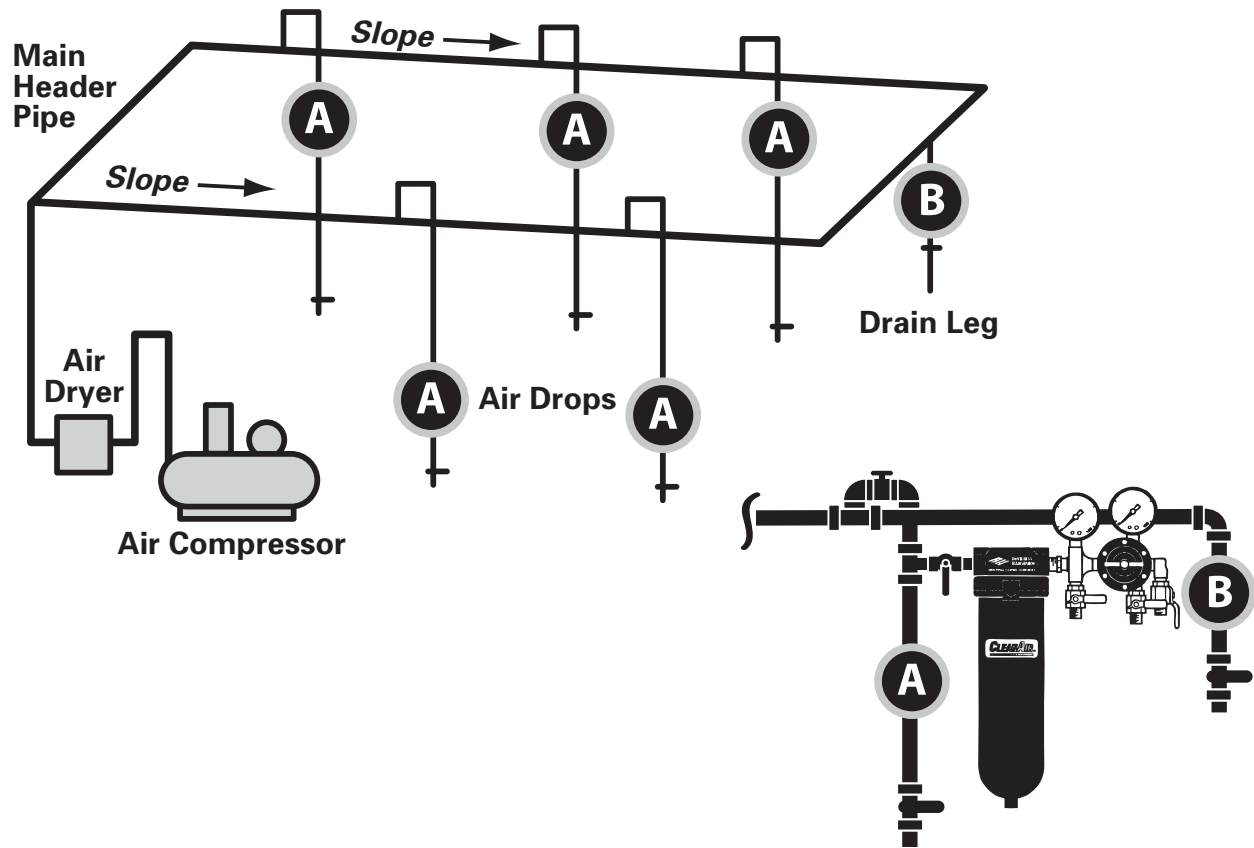

Centrifugal Air Filters

Part Number	Capacity	Type	Gauge	Repair Kit	Service Form
HAF-502	100 cfm@ 90 psi	In-line	None	None	SB-6-146
HAF-503	150 cfm@ 90 psi	In-line	None	None	SB-6-148
HAF-505	55 cfm@ 90 psi	In-line	None	None	SB-6-152

Air Supply Controls & Gauges

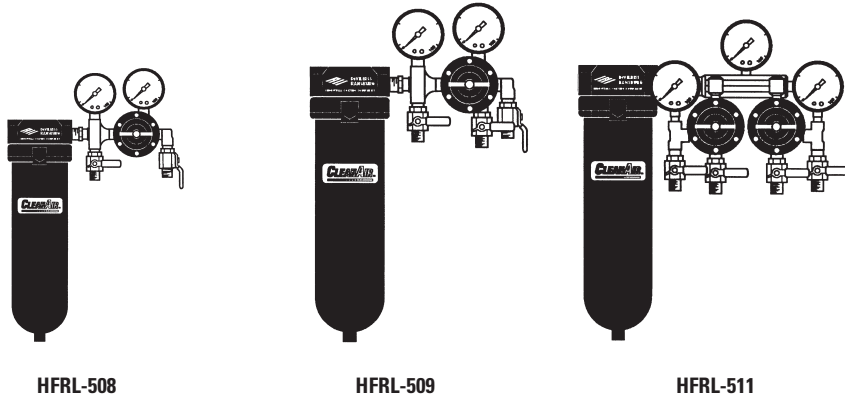

Centrifugal Filter/Regulator Units

Part Number	Description	Inlet	Outlet(s)	Inlet Press. Max.	Outlet Press. Min.	Outlet Press. Max.
HFRL-508	Centrifugal filter / regulator unit	1/2" npt(f)	2 ea 1/4" nps(m) regulated and 1, 1/4" nps(m) non-regulated	150 psi	0 psi	150 psi
HFRL-509	Centrifugal filter / regulator unit	3/4" npt(f)	2 ea 1/4" nps(m) regulated and 1, 1/4" nps(m) non-regulated	150 psi	0 psi	150 psi
HFRL-511	Centrifugal filter / regulator unit	3/4" npt(f)	2ea 1/4" nps(m) regulated and 2, 1/4" nps(m) non-regulated	150 psi	0 psi	150 psi

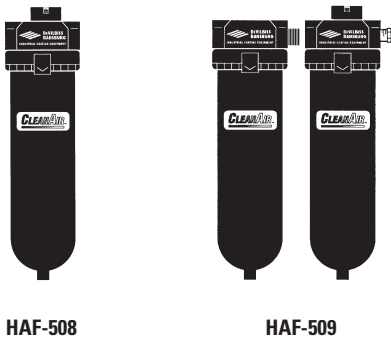

DeVilbiss CleanAir centrifugal units supply cleaner, drier air to each spray gun in a system. This cleaner air can also increase the life of pneumatic tools.

- Filters out water and oil aerosols and dirt particulates to 5 microns.
- Ideal for most spray applications, air tools and equipment.
- Water droplets collected in the bowl are removed by an automatic drain (standard feature). No need to manually drain.

Coalescer and Centrifugal/Coalescer Filter Units

Part Number	Description	Inlet	Outlet(s)	Inlet Press. Max.	Outlet Press. Min.	Outlet Press. Max.
HAF-508	Coalescer filter unit	3/4" npt(f)	3/4" npt(f)	150 psi	0 psi	150 psi
HAF-509	Centrifugal & coalescer filter unit	3/4" npt(f)	3/4" npt(f)	150 psi	0 psi	150 psi

Air Supply Controls & Gauges

Centrifugal Filter/Regulator Units

Part Number	Capacity	Type	Gauge	Repair Kit	Service Form
HFRL-508	60 Plus	In-line	GA-288 / 83-2727	KK-4977	SB-6-146
HFRL-509	80 Plus	In-line	GA-288 / 83-2727	KK-4977	SB-6-148
HFRL-511	120 Plus	In-line	GA-288 / 83-2727	KK-4977	SB-6-148

CleanAir coalescer filters remove water, dirt and oil from the system down to .01 micron. DeVilbiss coalescer filter units are designed with a quick-release bowl and spin-off element for filter changes without tools. In addition, a filter-change indicator alerts the operator when the element requires changing.

- Borosilicate glass microfiber filter is engineered for high flow, high efficiency, quick change and low pressure drop.
- Ideal for most spray applications, especially where oil aerosols may be a problem.
- Automatic bowl drain and 6' hose eliminate oil and water buildup (standard feature). No need to manually drain.

Coalescer and Centrifugal/Coalescer Filter Units

Part Number	Capacity	Type	Gauge	Repair Kit	Service Form
HAF-508	150 cfm	In-line	None	KK-4977	SB-6-148
HAF-509	150 cfm	In-line	None	KK-4977	SB-6-148

Air Supply Controls & Gauges

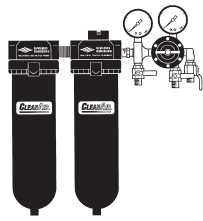

HFRL-512

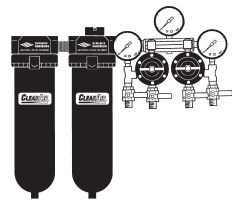

HFRL-513

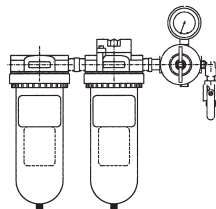

HAF-518

Centrifugal/Coalescer/Filter Regulator Units

Part Number	Description	Inlet	Outlet(s)	Inlet Press. Max.	Outlet Press. Min.	Outlet Press. Max.
HFRL-512	CENTRIFUGAL - coalescer - filter regulator unit	3/4" npt(f)	2ea 1/4" nps(m) regulated and 1, 1/4" nps(m) non-regulated	150 psi	0 psi	150 psi
HFRL-513	CENTRIFUGAL - coalescer - filter regulator unit	3/4" npt(f)	4ea 1/4" nps(m) regulated	150 psi	0 psi	150 psi
HAF-518	CENTRIFUGAL - coalescer - filter regulator unit	3/4" npt(f)	1ea 1/4" nps(m) regulated	150 psi	0 psi	150 psi

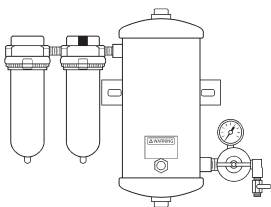

The three-stage desiccant unit provides the ultimate in clean dry air. First stage centrifugal filter removes particulates to 5 microns. Stage two coalescer filters down to .01 micron. Third stage desiccant removes remaining water vapor to a dew point of -40°F.

- Ideally suited for low to medium production.
- DAD-500 air-drying system includes three filtering units, as well as a wall mount bracket and desiccant filter change indicator.

3 Stage Desiccant Filter Unit

Part Number	Description	Inlet	Outlet(s)	Inlet Press. Max.	Outlet Press. Min.	Outlet Press. Max.
DAD-500	3 Stage desiccant air dryer	1/2" npt(f)	1/4" nps(m) regulated	150 psi	0 psi	150 psi

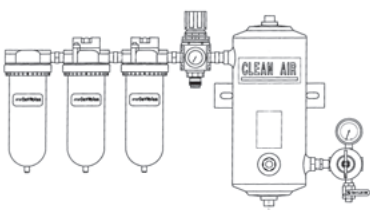

- Converts shop air into clean, dry, contaminant-free air for breathing systems and spray operations
- 5 micron particulate filter (Stage 1)

- .01 micron coalescing filter (Stage 2)
- Charcoal filter for hydrocarbon and odor removal (Stage 3)
- 28 cfm breathing air regulator

4 Stage Desiccant Filter Unit

Part Number	Description	Inlet	Outlet(s)	Inlet Press. Max.	Outlet Press. Min.	Outlet Press. Max.
DAD-503	4 Stage desiccant air dryer breathable	1/2" npt(f)	1/4" nps(m) regulated & breathable air outlet quick disconnect	150 psi	0 psi	150 psi

Air Supply Controls & Gauges

Coalescer/Filter Regulator Units

Part Number	Capacity	Type	Gauge	Repair Kit	Service Form
HFRL-512	80 Plus	In-line	GA-372 / GA-373	KK-4977	SB-6-145, SB-6-148
HFRL-513	120 Plus	In-line	GA-372 / 2ea GA-373	KK-4977	SB-6-145, SB-6-148
HAF-518	55 cfm	In-line	GA-288	KK-4977	SB-6-146, SB-6-152

- Centrifugal and coalescer units include automatic bowl drain (standard feature). No need to manually drain.
- Coalescer filter includes filter change indicator.
- Desiccant filter includes sight glass indicator (Changes color when desiccant needs replacement).

3 Stage Desiccant Filter Unit

Part Number	Capacity	Type	Gauge	Repair Kit	Service Form
DAD-500	25 cfm	Key / t-handle / in-line	GA-288	KK-4977	SB-6-156

- Desiccant system removes water vapor for spray gun (rated for 25 cfm maximum flow)
- 60 cfm spray gun regulator
- Automatic drains (Stages 1, 2 and 3)
- Can be used with up to four Air Vizors

4 Stage Desiccant Filter Unit

Part Number	Capacity	Type	Gauge	Repair Kit	Service Form
DAD-503	25 cfm / 60 cfm	Key / t-handle / in-line	GA-288 / GA-316	KK-5045 diaphragm kit	SB-6-159

Air Supply Controls & Gauges

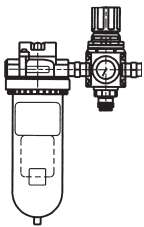

DAD-504

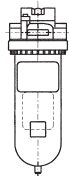

HAF-517

- Converts DAD-500 into a breathing air source
- Charcoal filter for hydrocarbon and odor removal
- 28 cfm breathing air regulator. Includes all necessary fittings
- Can be used with up to four DeVilbiss Air Vizors
- Automatic drain

1 Stage Charcoal Filter with Regulator

Part Number	Description	Inlet	Outlet(s)	Inlet Press. Max.	Outlet Press. Min.	Outlet Press. Max.
DAD-504	1 Stage charcoal filter and regulator kit	1/2" npt(f)	1/2" npt(m)	150 psi	0 psi	150 psi
HAF-517	1 Stage charcoal filter only	1/2" npt(f)	1/2" npt(f)	150 psi	0 psi	150 psi

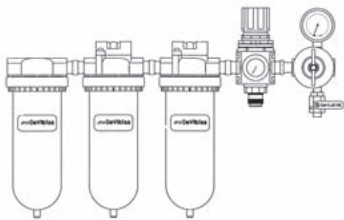

- Converts shop air into clean, contaminant-free air for breathing systems and spray operations
- 5 micron particulate filter (Stage 1)
- .01 micron coalescing filter (Stage 2)
- Charcoal filter for hydrocarbon and odor removal (Stage 3)
- 28 cfm breathing air regulator
- 60 cfm spray gun regulator

3 Stage Breathing Air Filter with Regulators

Part Number	Description	Inlet	Outlet(s)	Inlet Press. Max.	Outlet Press. Min.	Outlet Press. Max.
HAF-601	3 Stage breathing air filter with regulators	1/2" npt(f)	1/4" nps(m) & breathable air outlet quick disconnect	150 psi	0 psi	150 psi



A unique product in the finishing market

- FRC-650 All-In-One combines a filter, regulator and coalescer for shop air into one compact unit.
- Four 1/4" nps(m) ball valves with unrestricted air passages, (three regulated plus one unregulated outlet.)

2 Stage Filter/Regulator and Coalescer

Part Number	Description	Inlet	Outlet(s)	Inlet Press. Max.	Outlet Press. Min.	Outlet Press. Max.
FRC-650	All in one – filter, regulator, coalescer	1/2" npt(f)	1/4" nps(m) 3 reg & 1 main line air	150 psi	0 psi	125 psi

Air Supply Controls & Gauges

1 Stage Charcoal Filter with Regulator

Part Number	Capacity	Type	Gauge	Repair Kit	Service Form
DAD-504	28 cfm	Knob / in-line	GA-316	See lit	SB-6-176
HAF-517	28 cfm	N/A	N/A	N/A	SB-6-176

- Automatic drains (Stages 1, 2 and 3)
- Wall-mount bracket
- Can be used with up to four Air Visors

3 Stage Breathing Air Filter with Regulators

Part Number	Capacity	Type	Gauge	Repair Kit	Service Form
HAF-601	28 cfm / 60 cfm	Knob / t-handle / in-line	GA-288 / GA-316	See lit	SB-6-132

- Ball valves inclined 45°—avoids kinking of hoses, which increases life span.
- Robust and durable.
- Solvent-resistant filter bowl and body is indispensable in the spray area.
- Solvent- and slip-resistant knob for easy air adjustment.
- Automatic drains at each stage eliminate water build-up—no need to manually drain.

2 Stage Filter/Regulator and Coalescer

Part Number	Capacity	Type	Gauge	Repair Kit	Service Form
FRC-650	100 cfm	Knob	FRC-012 / FRC-046	K-4106/7/8	SB-6-377

Air Supply Controls & Gauges



HAF-6, HAF-15,
HAF-28, HAF-36



HAF-38



Filter Element Kits

Filter Assy. Part Number	Filter Element Kit	Mounting Hardware Kit Optional Parts	Service Form
DAD-500	HAF-6, HAF-28, DAD-1	n/a	SB-6-156
DAD-503	HAF-6, HAF-28, HAF-36, DAD-1	HAF-407	SB-6-159
DAD-504	K-4106	K-4107	SB-6-377
FRC-650	HAF-36	n/a	SB-6-176
HAF-502	HAF-6	HAF-407	SB-6-146
HAF-503	HAF-15	HAF-408	SB-6-148
HAF-505	HAF-28	n/a	SB-6-152
HAF-508	HAF-38	HAF-408	SB-6-148
HAF-509	HAF-15, HAF-38	HAF-408	SB-6-148
HAF-601	HAF-6, HAF-28, HAF-36	HAF-407	SB-6-132
HFRL-508	HAF-6	HAF-407	SB-6-146
HFRL-509	HAF-15	HAF-408	SB-6-148
HFRL-511	HAF-15	HAF-408	SB-6-148
HFRL-512	HAF-15, HAF-38	HAF-408	SB-6-148
HFRL-513	HAF-15, HAF-38	HAF-408	SB-6-148
849303	873209	849305	849303

Air Vizor™ Breathable Air Systems & Filtration Units

Order No. Model No.	Belt Regulator and Hood Assembly	Breathable Air Hose (30')	No. of Visor Covers Included	Filtration Unit Included	Filtration Description
MPV-625	Yes	No	2	None	—
MPV-650	Yes	Yes	12	DAD-504	Desiccant Retrofit System
MPV-651	Yes	Yes	12	DAD-503	3 Stage Filtration with Desiccant Air Dryer System
MPV-652	Yes	Yes	12	HAF-601	3 Stage Filtration System

*Air Vizor™ requires proper air line filtration and carbon monoxide (CO) monitoring to complete an approved supplied air respirator. See descriptions at right for proper air line filtration.

A carbon monoxide (CO) monitor may be purchased locally or from ENMET Corporation: (734) 761-1270 (phone). Order form F-1073-C available from DeVilbiss upon request.



The filtration units above are only one part of a complete breathable air system. These must be combined with a supplied air respirator and Grade D breathable air. A carbon monoxide (CO) monitor must also be used.

Air Supply Controls & Gauges



HAV-500



HAV-501



P-H-5516



HARG-510

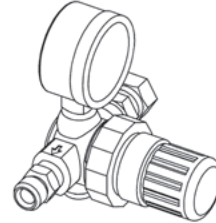

85-441

Air Adjusting Valves/Needle Valves/Cheater Valves

Part Number	Type	Inlet Size	Outlet Size	W or W/O Gauge Assy.	Max. Working Pressure	Recommended Range	Service Form
873409	Straight	1/4"npt(f)	1/4"npt(f)	W/O	100 psi	0-100 psi	n/a
HAV-500	Straight	1/4"nps(m)	1/4"nps(f)	W/O	125 psi	0-125 psi	SB-11-119
HAV-501	Straight	1/4"nps(m)	1/4"nps(f)	W / Gauge	125 psi	0-125 psi	SB-11-119
73-159	90 Degree	1/4"nps(m)	1/4"nps(f)	W/O	250 psi	0-125 psi	n/a
P-H-5516	45 Degree	1/4"nps(m)	1/4"nps(f)	W/O	250 psi	0-125 psi	SB-11-119
HARG-510	Regulator	1/4"nps(m)	1/4"nps(f)	W / Gauge	300 psi	0-160 psi	SB-6-105
85-441	Regulator	1/4"nps(m)	1/4"nps(f)	W / Gauge	300 psi	0-50 psi	77-2825

Air Supply Controls & Gauges



GA-288



GA-385



849306

Air Pressure Gauges

Part No.	Capacity Pressure	Thread Size & Position		Notes
		Bottom	Back	
59-299	15		1/8" npt(m)	Panel mount
83-1636	15	1/4" npt(m)		
GA-313	15	1/8" npt(m)		1-1/2" diameter
83-1414	30	1/4" npt(m)		
GA-73	30	1/4" npt(m)		2" diameter
GA-77	30	1/4" npt(m)		3-1/2" diameter (0-10# shown in ounces, 10-30 in #s)
GA-355	30	1/8" npt(m)		1-1/2" diameter
59-369	60		1/8" npt(m)	
85-70	60	1/8" npt(m)		
83-1355	100	1/4" npt(m)		
83-2571	100	1/4" npt(m)		Stainless steel
83-2727	100	1/4" npt(m)		83-2290 (Lens)
GA-385	100		1/4" npt(m)	2" diameter
83-1290	150	1/4" npt(m)		Used on tanks
GA-288	160	1/4" npt(m)		2" diameter
GA-316	160		1/4" npt(m)	2" diameter
GA-338	160		1/8" npt(m)	1-1/2" diameter
849306	160	1/4" npt(m)	1/4" npt(m)	
83-2744	200	1/4" npt(m)		
83-387	200	1/4" npt(m)		83-2052 (Lens)
84-246	200	1/4" npt(m)		w / pulse. diaphragm

Cups, Cup Accessories & Misc. Products

SIPHON CUPS	8-2
PRESSURE CUPS	8-3
GRAVITY FEED CUPS	8-4
REMOTE PRESSURE CUPS	8-5
CUP ACCESSORIES	8-6
MISC. PRODUCTS	8-7

Cups, Cup Accessories & Misc. Products

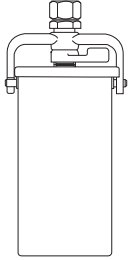

81-540

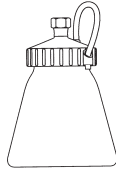

81-384



TGS-503

Siphon Cups – 1/4" nps Thread For Touch-up Guns

Part Number	Capacity	Wetted Materials	Type	Guns Used With	Service Form
81-540	8 oz	Aluminum	Standard	115	77-1261
81-384	8 oz	Polyethylene	Drip proof	MACH 1, Cub	77-2741
TGS-503	8 oz	Polyethylene	Standard	EGA, EGHV, misc.	SB-4-090

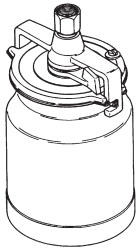

TGC-545, TLC-555,
TSC-595

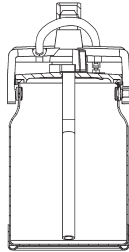

81-800, 81-810



81-820

Siphon Cups – 3/8" nps Thread For Full Size Guns

Part Number	Capacity	Wetted Materials	Type	Guns Used With	Service Form
TGC-545	1 qt	Aluminum	Drip-free	All full size guns	SB-4-391
81-800	1 qt	Aluminum	Drip proof	All full size guns	77-2794
TLC-555	1 qt	Alum-teflon lined	Drip-free	All full size guns	SB-4-391
81-810	1 qt	Alum-teflon lined	Drip proof	All full size guns	77-2795
TSC-595	1 qt	Stainless steel	Drip-free	All full size guns	SB-4-395
81-820	1 qt	Stainless steel	Drip proof	All full size guns	77-2821

Cups, Cup Accessories & Misc. Products

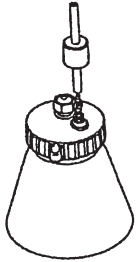

81-382

Pressure Cup (gun attached) – 1/4" nps Thread For Mach 1 Cub and CubSL only

Part Number	Capacity	Wetted Materials	Type	Guns Used With	Service Form
81-382	8 oz	Polyethylene	10 psi	MACH 1 Cub & Cub SL only	77-2724

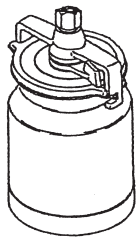

TLC-576, TSC-591

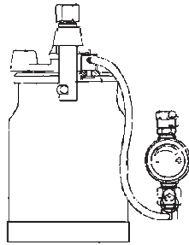

TGC-600

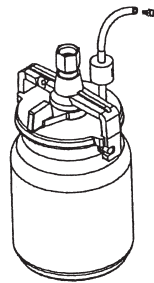

80-500

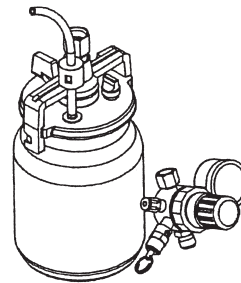

80-511

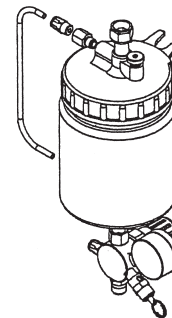

80-294

Pressure Cups (gun attached) – 3/8" nps Thread For Full Size Guns

Part Number	Capacity	Wetted Materials	Type	Notes	Service Form
TLC-576	1 qt	Aluminum	20 psi	Requires KK-4980	SB-4-367
TGC-600	1 qt	Aluminum	20 psi	Includes KK-4980	SB-4-367
TSC-591	1 qt	Stainless steel	20 psi	Requires KK-4980	SB-4-367
80-500	1 qt	Stainless steel	20 psi	Includes short tube (MACH 1 & MACH 1SL only)	77-2820
80-510	1 qt	Stainless steel	15 psi	Includes long tube (requires 85-435 regulator)	77-2820
80-511	1 qt	Stainless steel	15 psi	Includes long tube and 85-435 regulator	77-2820
80-294	1 qt	Aluminum	50 psi max	Includes tube and 85-445 regulator	77-2822

Cups, Cup Accessories & Misc. Products

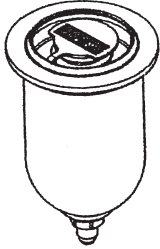

54-4458



81-381

Gravity Feed Cups – 7/16" -14 (m) Thread for Touch-up Guns

Part Number	Capacity	Wetted Materials	Guns Used With	Service Form
54-4458	4 oz	Aluminum	Cub SLG & SRI touchup guns	77-2719
SRI-478-K12	4 oz	Nylon (disopsable)	SRI and Compact Mini	SB-2-525
SRI-510	4 oz	Acetal	SRI and Compact Mini	SB-2-525
81-381	8 oz	Aluminum	SRI and Compact Mini	77-2739

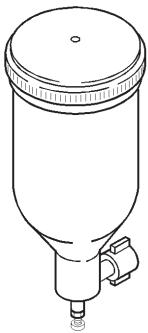

Gravity Feed Cup – 1/4" -19 bsp (f) Swivel (For TGHV-635 Gun Only)

Part Number	Capacity	Wetted Materials	Service Form
TGHV-415	8 oz	Stainless steel	SB-2-192

Cups, Cup Accessories & Misc. Products

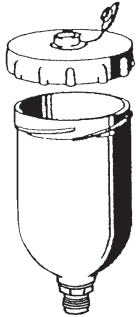

Gravity Feed Cups — 3/8" -19 bsp (m) Thread For Full Size Guns

Part Number	Capacity	Wetted Materials	Guns Used With	Service Form
KGP-509-1	8 oz	Nylon	EXL, M1-G, FLG-2, FLG-3 full size guns, 95G, SV-100	SB-4-042
GFC-501	20 oz	Acetal	EXL, M1-G, FLG-2, FLG-3 full size guns, 95G, SV-100	SB-4-261
GFC-502	1 Liter	Aluminum	EXL, M1-G, FLG-2, FLG-3 full size guns, 95G, SV-100	SB-4-043
54-4720	1 Liter	Aluminum	EXL, M1-G, FLG-2, FLG-3 full size guns, 95G, SV-100	SBBI-4-043

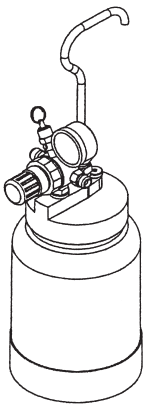

80-295

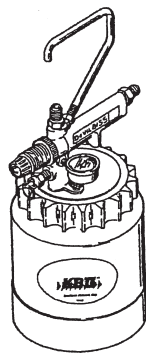

KB-555, KB-545-SS

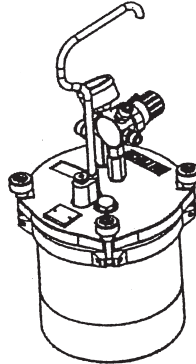

80-600, 80-601, 80-651

Pressure Cups (remote from gun)

Part Number	Capacity	Wetted Materials	Service Form
80-295	2 Quart	Aluminum	77-2823
KB-555	2 Quart	Aluminum	SB-4-205
80-600	2 Quart	Aluminum & stainless steel	77-2841
KB-545-SS	2 Quart	Stainless steel	SB-4-205
80-601	2 Quart	Aluminum & stainless steel	77-2841
80-651	2 Quart	Aluminum & stainless steel	77-2842

Cups, Cup Accessories & Misc. Products



TGS-406



149-278

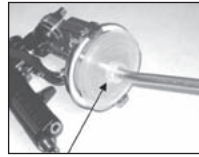

KR-115-K5



KK-5051

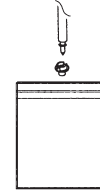

OMX-70-K48



KGP-5-K5



81-82, 81-83, 81-84

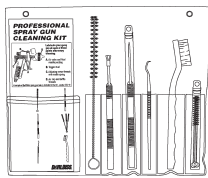

192212



OMX-88



42884-215-K10



42884-214-K5

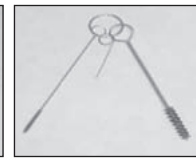

KK-5060



HD-503, 83GZ-5200

Cup Accessories

Part Number	Description	Notes
TGS-406	Storage cup with lid	Compatible with TGS-503 suction cup
149-278	Siphon/suction cup inlet screen 50 mesh	10 Per box, fits on p/u tube
KR-115-K5	Diaphragm lid protector	Package of 5, prevents cup leaks
KK-5051	Kb cup liners 20/pkg	For KB-545-SS & KB-555 2 qt cups
OMX-70-K48	Gravity cup liners & bushings	Fits most 1 qt & 1 liter cups
KGP-5-K5	Gravity cup strainers 50 mesh,	Package of 5
81-82	145 Mesh 1 quart cup strainers	Box of 5
81-83	100 Mesh 1 quart cup strainers	Box of 5
81-84	80 Mesh 1 quart cup strainers	Box of 5
192212	Professional spray gun cleaning kit	Works for all guns
54-4994	Gun cleaning kit	Includes: wire tool tip cleaner, 1/4" dia round brush, flat brush (not shown)
OMX-88	Flat brush	
54-4133	1/4" Dia round brush	For cleaning of air & fluid passages (not shown)
82-469	5/8" Dia round brush	For cleaning of air & fluid passages (not shown)
42884-215-K10	5/8" Dia spiral brush	Package of 10, for cleaning of air & fluid passages
42884-214-K5	3/8" Dia spiral brush	Package of 5, for cleaning of air & fluid passages
KK-5060	Air cap cleaning kit	Includes: wire tool, 1/4" diameter spiral brush, 3/21" diameter spiral brush
83GZ-5200	Solvent saver	2 Gallons
HD-503	Hose/gun cleaner	2 Quarts
KK-5052	Adapter fitting and hose kit	For solvent saver & KB series cups (not shown)

Cups, Cup Accessories & Misc. Products



6580-0000-1



SSL-10-K12



6-429



40-3568, 40-3569



863009, 42-175, 207-11155, 863020

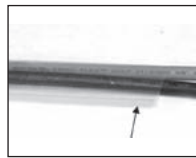

MSVAD-416

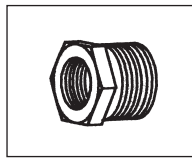

49-1834

Misc. Products

Part Number	Description
6580-0000-1	Model 190 dusting gun w 60-40 nozzle
6580-6041-0	Model 190 dusting gun w 60-41 nozzle extension 5-1/2" long (not shown)
SSL-10-K12	Devilbiss gun lube 12 ea 2 oz bottles
6-429	Binks Gunners Mate gun lube 20 ea 2 oz bottles
40-3568	Zahn EZ #2 viscosity cup
40-3569	Zahn EZ #3 viscosity cup
41-3134	Binks Pump Purge, case of 12 (not shown)
863009	Wet-Sol upper pump packing lubricant 1 quart
42-175	Pump packing lubricant 1 quart
863020	Air line lubricant 1 quart
207-11155-1	Air motor lubricant 2 oz
207-11155-2	Air motor lubricant 16 oz (not shown)
207-11155-3	Air motor lubricant 1 gallon (not shown)
MSVAD-416	Polyethylene hose sleeve 100 ft
237-707	1-80 Wet film mil gauge (not shown)
49-1834	Adapter fitting 3/4" -20 female x 7/8" -14 male used to convert typical threads for tip extensions, tip bases, etc.